

Technical data sheet

Throughbeam photoelectric sensor transmitter

Part no.: 50126605

LS318B.Y1

Contents

- Technical data
- Dimensioned drawings
- Electrical connection
- Diagrams
- Operation and display
- Suitable receivers
- Part number code
- Notes
- Further information
- Accessories



For illustration purposes only



Technical data

Basic data

Series	318B
Operating principle	Throughbeam principle
Device type	Transmitter

Special version

Special version	Deactivation input Small light spot (S)
-----------------	--

Optical data

Operating range	0 ... 9.4 m (guaranteed operating range)
Operating range limit	0 ... 14.2 m (typical operating range)
Light source	LED, Red
Wavelength	620 nm
Transmitted-signal shape	Pulsed
LED group	Exempt group (in acc. with EN 62471)

Electrical data

Protective circuit	Polarity reversal protection Short circuit protected
--------------------	---

Performance data

Supply voltage U_B	10 ... 30 V, DC, Incl. residual ripple
Residual ripple	0 ... 15 %, From U_B
Open-circuit current	0 ... 15 mA

Inputs

Number of deactivation inputs	2 Piece(s)
-------------------------------	------------

Deactivation inputs

Type	Deactivation input
Deactivation input 1	
Active switching state	Low
Deactivation input 2	
Active switching state	High

Time behavior

Readiness delay	300 ms
-----------------	--------

Connection

Number of connections	1 Piece(s)
-----------------------	------------

Connection 1

Function	Signal IN Voltage supply
Type of connection	Connector
Thread size	M12
Type	Male
Material	Plastic
No. of pins	4 -pin
Encoding	A-coded

Mechanical data

Dimension (\varnothing x L)	18 mm x 46 mm
Thread size	M18 x 1 mm
Housing material	Plastic
Plastic housing	ABS
Lens cover material	Plastic
Net weight	20 g
Housing color	Black Red

Operation and display

Type of display	LED
Number of LEDs	1 Piece(s)

Environmental data

Ambient temperature, operation	-40 ... 60 °C
Ambient temperature, storage	-40 ... 70 °C

Certifications

Degree of protection	IP 67
Protection class	III
Approvals	c UL US
Standards applied	IEC 60947-5-2

Classification

Customs tariff number	85365019
ECLASS 5.1.4	27270901
ECLASS 8.0	27270901
ECLASS 9.0	27270901
ECLASS 10.0	27270901
ECLASS 11.0	27270901
ECLASS 12.0	27270901
ECLASS 13.0	27270901
ECLASS 14.0	27270901
ECLASS 15.0	27270901
ECLASS 16.0	27270901
ETIM 5.0	EC002716
ETIM 6.0	EC002716
ETIM 7.0	EC002716
ETIM 8.0	EC002716
ETIM 9.0	EC002716
ETIM 10.0	EC002716
UNSPSC 26.08	39121528

Dimensioned drawings

All dimensions in millimeters

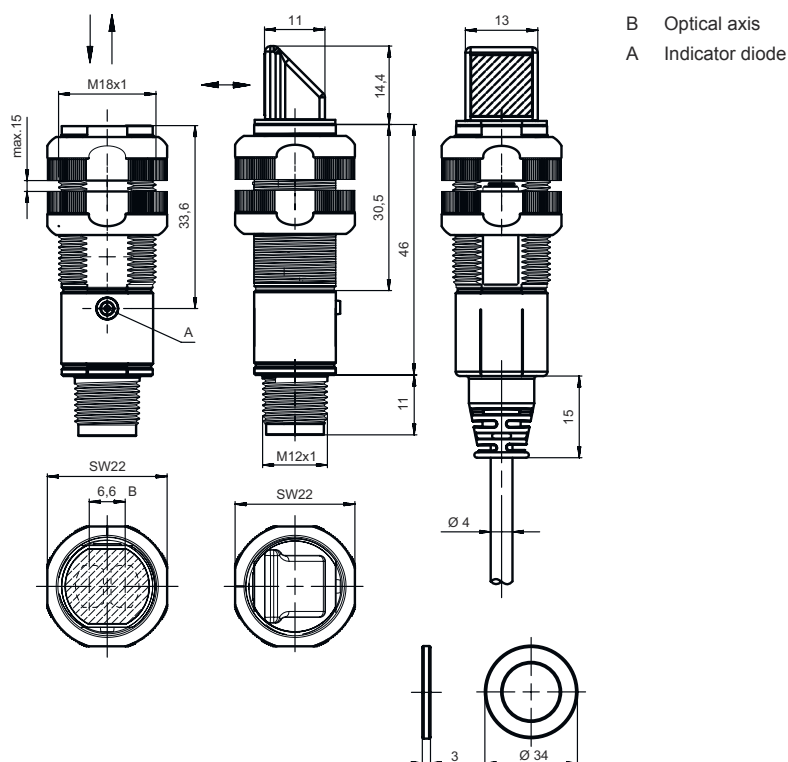

Electrical connection

Connection 1

Function	Signal IN Voltage supply
Type of connection	Connector
Thread size	M12
Type	Male
Material	Plastic
No. of pins	4 -pin
Encoding	A-coded

Pin Pin assignment

Pin	Pin assignment
1	V+
2	IN2
3	GND
4	IN1

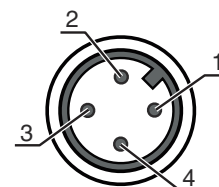

Diagrams

Typ. response behavior

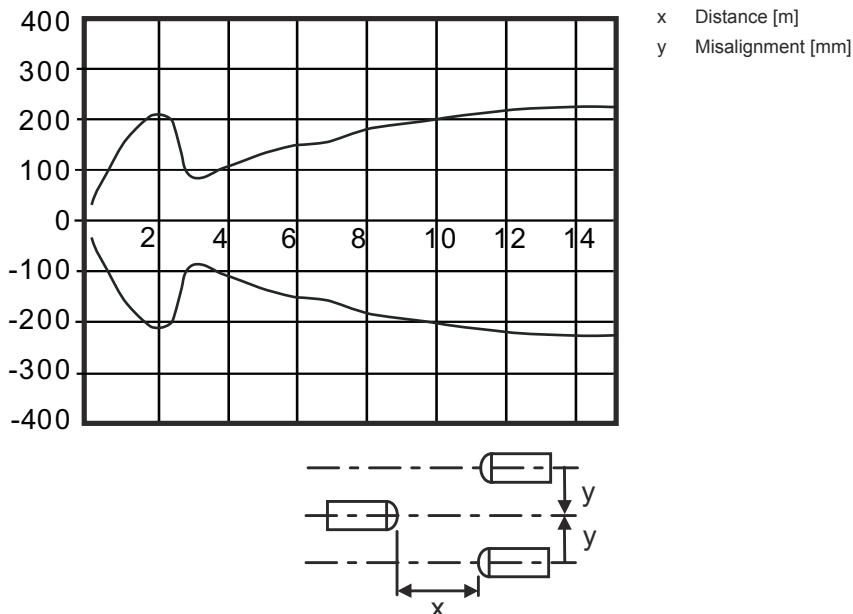

Operation and display

LED	Display	Meaning
1	Green, continuous light	Operational readiness
	Yellow, continuous light	Transmitted beam active

Suitable receivers

	Part no.	Designation	Operating range Operating range limit	Description
	50116845	LE318B/2N-M12	0 ... 10 m 0 ... 15 m	Supply voltage: DC Digital switching outputs: 2 Piece(s) Switching output 1: Transistor, NPN, Light switching Switching output 2: Transistor, NPN, Dark switching Switching frequency: 500 Hz Connection: Connector, M12, Plastic, 4 -pin
	50116847	LE318B/4P-M12	0 ... 10 m 0 ... 15 m	Supply voltage: DC Digital switching outputs: 2 Piece(s) Switching output 1: Transistor, PNP, Light switching Switching output 2: Transistor, PNP, Dark switching Switching frequency: 500 Hz Connection: Connector, M12, Plastic, 4 -pin

Part number code

Part designation: XXX318BY-AAAF.BB/CC-DDD

XXX318B	Operating principle
	PRK: Retro-reflective photoelectric sensor with polarization filter
	ET: energetic diffuse reflection sensor
	FT: diffuse reflection sensor with fading
	LE: Throughbeam photoelectric sensor receiver
	LS: throughbeam photoelectric sensor transmitter

Part number code

Y	Light type n/a: red light l: infrared light
AAAF	Preset range (optional) n/a: operating range acc. to data sheet xxxF: Preset range [mm]
BB	Equipment n/a: axial optics W: 90° angular optics 3: teach-in via button X: reinforced fading
CC	Switching output / function (OUT1 = pin 4, OUT2 = pin 2): 4: PNP transistor output, light switching P: PNP transistor output, dark switching 2: NPN transistor output, light switching N: NPN transistor output, dark switching 9: input for transmitter deactivation (deactivation with HIGH signal) D: Input for transmitter deactivation (deactivation with LOW signal) X: pin not used
DDD	Electrical connection n/a: cable, standard length 2000 mm, 4-wire M12: M12 connector, 4-pin (plug) 5000: cable, standard length 5000 mm, 4-wire 200-M12: cable, length 200 mm with M12 connector, 4-pin, axial (plug)

Note



A list with all available device types can be found on the Leuze website at www.leuze.com.

Notes



Observe intended use!



- ⌘ This product is not a safety sensor and is not intended as personnel protection.
- ⌘ The product may only be put into operation by competent persons.
- ⌘ Only use the product in accordance with its intended use.

For UL applications:





- ⌘ For UL applications, use is only permitted in Class 2 circuits in accordance with the NEC (National Electric Code).
- ⌘ These proximity switches shall be used with UL Listed Cable assemblies rated 30V, 0.5A min, in the field installation, or equivalent (categories: CYJV/ CYJV7 or PVVA/PVVA7)

Further information

- Sum of the output currents for both outputs, 50 mA for ambient temperatures > 40°C

Accessories

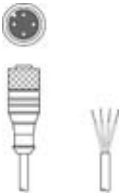
Connection technology - Connection cables

	Part no.	Designation	Article	Description
	50130652	KD U-M12-4A-V1-050	Connection cable	Application: Chemical resistant Connection 1: Connector, M12, Axial, Female, A-coded, 4 -pin Connector, LED: No Connection 2: Open end Shielded: No Cable length: 5,000 mm Sheathing material: PVC
	50130690	KD U-M12-4W-V1-050	Connection cable	Application: Chemical resistant Connection 1: Connector, M12, Angled, Female, A-coded, 4 -pin Connector, LED: No Connection 2: Open end Shielded: No Cable length: 5,000 mm Sheathing material: PVC



Mounting technology - Mounting brackets

	Part no.	Designation	Article	Description
	50113548	BT D18M.5	Mounting bracket	Diameter, inner: 18 mm Design of mounting device: Angle, L-shape Fastening, at system: Through-hole mounting Mounting bracket, at device: Screw type Type of mounting device: Rigid Material: Stainless steel

Mounting technology - Rod mounts

	Part no.	Designation	Article	Description
	50117490	BTU D18M-D12	Mounting system	Design of mounting device: Mounting system Fastening, at system: Through-hole mounting Mounting bracket, at device: Screw type Type of mounting device: Clampable, Adjustable, Turning, 360° Material: Metal

Mounting technology - Other

	Part no.	Designation	Article	Description
	50117258	BT 318P-LS	Fastening	Contains: 10x Design of mounting device: Mounting clamp Fastening, at system: Through-hole mounting Mounting bracket, at device: Clampable Type of mounting device: Rigid Material: Plastic Shock absorber: No
	50121904	BT318B-OM	Fastening	Design of mounting device: Mounting clamp Fastening, at system: Through-hole mounting Mounting bracket, at device: Screw type Type of mounting device: Swiveling, Adjustable, Turning Material: Plastic Shock absorber: No

Accessories

Note



🔗 A list with all available accessories can be found on the Leuze website in the Download tab of the article detailed page.