

技术数据表

带背景抑制的漫反射传感器

配件编号: 50142302

HRT 25B/L6T.32-2500-S12



图片可能不同

内容

- 技术参数
- 尺寸图纸
- 电气连接
- 图示
- 操作和显示
- 产品型号描述
- 说明
- 更多信息
- 配件



技术参数

基础数据

系列	25B
工作原理	带背景抑制的扫描原理

专门设计

专门设计	2 个独立开关量输出 示教输入 通过 IO-Link 示教
------	-------------------------------------

光学数据

检测距离	0.05 ... 2.5 m (保证的检测范围)
检测范围极限	0.05 ... 3 m (典型检测范围)
射线走向	发散
光源	LED, 红外线
波长	850 nm
传输信号波形	脉冲
LED 组	自由组 (根据 EN 62471)
光斑直径 [针对传感器距离]	60 mm [1,000 mm]
光斑几何形状类型	圆型

测量数据

重复性	<± 15 mm, 适用于 50 ... 2500 mm 的测量范围, 取决于亮度系数和物体距离, 在 20 °C 时加热 20 min. 后, 平均范围 U_B , 测量对象 $\geq 50 \times 50 \text{ mm}^2$
调节精度 (通过 IO-Link)	± 10 % (300 ... 2500 mm)
温度漂移	2 mm/K
黑/白背景屏蔽性能	25 mm, 亮度系数 2 ... 90 %

电气数据

保护电路	反极性保护 暂态保护 短路保护
------	-----------------------

性能数据

供电电压 U_B	18 ... 30 V, DC
剩余波纹度	0 ... 15 %, 来自 U_B
开路电流	0 ... 32 mA

输入端

示教输入数	1 个
-------	-----

示教输入

类型	示教输入
电压类型	DC
延迟	20 ms
输入电阻	10,000 Ω

示教输入 1

配置	连接1, 引脚5
----	----------

输出

数字开关量输出数	2 个
----------	-----

开关量输出

类型	数字开关量输出
电压类型	DC
最大开关电流	50 mA
开关电压	低: $\leq 2V$ 高: $\geq (U_B - 2V)$

开关量输出1

开关元件	晶体管, 推挽
开关原理	IO-Link / 亮通 (PNP) / 暗通 (NPN)

开关量输出2

开关元件	晶体管, 推挽
开关原理	亮通 (PNP)/暗通 (NPN)

时序

开关频率	2 ... 30 Hz, 取决于亮度系数
响应时间	70 ms, 取决于亮度系数
延时	300 ms

接口

类型	IO-Link
----	---------

IO-Link

COM模式	COM2
最小循环时间	COM2 = 2.3 ms
帧类型	2.1
规格书	V1.1.1
SIO-模式支持	是
双通道	是

连接

接口数量	1 个
------	-----

连接1

功能	供电电源 信号输入 信号输出
类型	接头
螺纹规格	M12
类型	插头
材料	塑料
引脚数	5 个引脚
编码	A-编码

机械参数

尺寸 (宽 x 高 x 长)	15 mm x 38.9 mm x 28.7 mm
外壳材料	塑料
塑料外壳	PC-ABS
镜头盖材料	塑料(PMMA)
净重	15 g
外壳颜色	红色
紧固类型	通孔安装 通过可选安装设备
推荐拧紧扭矩固定件 m3	0.9 N·m
推荐拧紧扭矩固定件 m4	1.4 N·m

操作和显示

显示类型	LED
LED数	3 个
操作控制	示教按钮
操作控制功能	扫描范围调整

环境数据

环境温度, 工作	-30 ... 50 °C
环境温度, 储藏	-40 ... 60 °C

技术参数

认证

防护等级	IP 66
	IP 67
安全等级	III
认证	c UL US
应用标准	IEC 60947-5-2

分类

税率编号	85365019
ECLASS 5.1.4	27270904
ECLASS 8.0	27270904
ECLASS 9.0	27270904
ECLASS 10.0	27270904
ECLASS 11.0	27270904
ECLASS 12.0	27270903
ECLASS 13.0	27270903
ECLASS 14.0	27270903
ECLASS 15.0	27270903
ECLASS 16.0	27270903
ETIM 5.0	EC002719
ETIM 6.0	EC002719
ETIM 7.0	EC002719
ETIM 8.0	EC002719
ETIM 9.0	EC002719
ETIM 10.0	EC002719

尺寸图纸

所有尺寸单位均为毫米

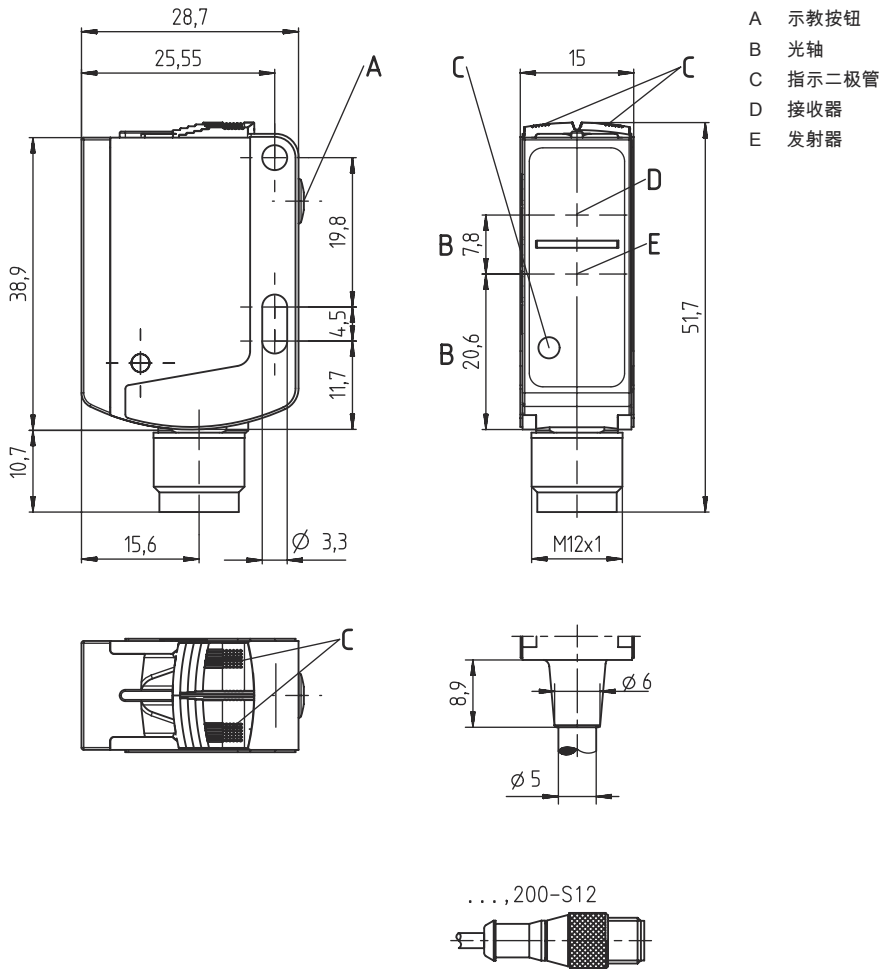

电气连接

连接1

功能	供电电源
	信号输入
	信号输出
类型	接头
螺纹规格	M12
类型	插头
材料	塑料
引脚数	5 个引脚
编码	A-编码

引脚 引脚分配

1	V+
2	OUT 2
3	GND
4	IO-Link/ OUT 1
5	IN 1

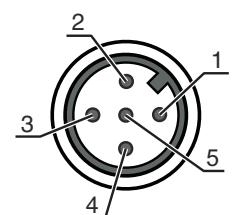

图示

响应动作类型

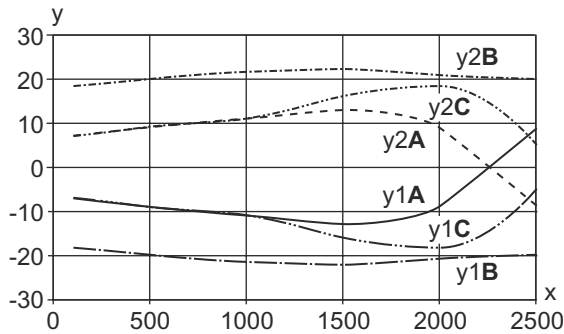

x 间距 [mm]
y 偏移 [mm]

y1/2A 物体: 白色, 背景: 白色
y1/2B 物体: 白色, 背景: 黑色
y1/2C 物体: 黑色, 背景: 黑色

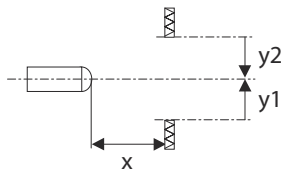

黑白背景屏蔽性能

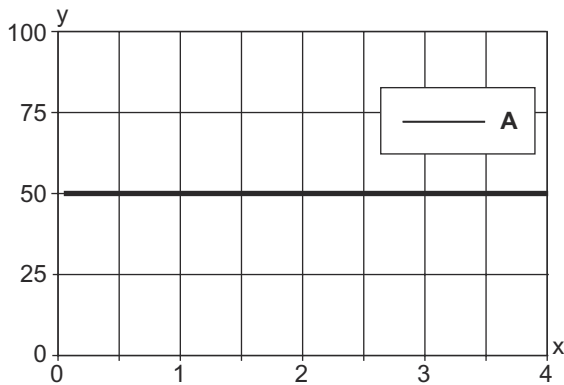

x 扫描宽度 [mm]
y 最大扫描范围更改 [mm] (参考: 白色 90%)
A 亮度系数4 ... 90 %

操作和显示

LED	显示	说明
1	绿色, 长亮	准备就绪
2	黄色, 长亮	物体已识别 (控制输出端 Q1)
3	黄色, 长亮	物体已识别 (控制输出端 Q1)
	蓝, 长亮	物体已识别 (控制输出端 Q2)
	白色, 长亮	物体已识别 (控制输出端 Q1 和 Q2)

产品型号描述

产品名称: AAA25B d EFG.HHH-i,J

AAA	功能原理 / 设计 HRT25B: 带背景抑制的漫反射传感器 ODT25B: 背景抑制距离传感器
d	光类型 取消: 红光

产品型号描述

E	引脚 4 / 黑色芯线分配 L: IO-Link (对于双通道也具备 Push/Pull (推挽) 控制输出端 Q1)
F	引脚 2 / 白色芯线分配 6: Push/Pull (推挽) 控制输出端 Q2
G	引脚 5 / 灰色芯线分配 6: Push/Pull (推挽) 控制输出端 Q3 9: 禁用输入端 (出厂设置) 或示教输入端 (> 8VDC, 可参数化) T: 用于外部示教输入的示教输入端 (> 8VDC, 可参数化) X: n.c.
HH	装备 32: 用于示教的示教按钮, 包括通过 IO-Link 进行扫描范围调整
i	扫描范围 xxxx: 最大工作扫描范围
J	电气连接 取消: 电缆, 长度 2000mm, 带线端套, 5 芯 -S12: M12 圆形连接器, 5 个引脚 ,200-S12 电缆, 长度 200 mm, 带 M12 圆连接器, 5 个引脚

注意



所有可用设备类型列表请查阅劳易测的网站 www.leuze.com。

说明



遵守设备的使用规定!



- 本产品并非安全传感器, 无法用于人员保护。
- 只能由专业人员将本产品投入运行。
- 请仅根据正确用途使用本产品。



针对UL应用:



- 对于UL应用, 按照NEC(美国国家电气规程)要求只允许在2级电路中使用。

更多信息

- 光源: 25°C环境温度时的平均使用寿命为100000小时
- 值适用于 50 ... 2500mm 的测量范围, 取决于亮度系数和物体距离, 在 20 °C 时加热 20 min. 后, 平均范围 U_B , 测量对象 $\geq 50 \times 50 \text{ mm}^2$

配件



连接技术 - 连接单元

	配件编号	名称	配件	说明
	50144900	MD 798i-11-82/L5-2222	IO-Link 主站	最大电流消耗: 11,000 mA 接口: IO-Link, EtherNet IP, Modbus TCP, PROFINET, 自动协议识别 连接: 12 个 传感器接口: 8 个 防护等级: IP 67, IP 65, IP 69K

连接技术 - 连接电缆

	配件编号	名称	配件	说明
	50130652	KD U-M12-4A-V1-050	连接电缆	应用: 耐化学品 连接1: 接头, M12, 直形, 插座, A-编码, 4 个引脚 圆接头, LED: 否 连接2: 开口端 有屏蔽: 否 电缆长度: 5,000 mm 护套材料: PVC
	50130690	KD U-M12-4W-V1-050	连接电缆	应用: 耐化学品 连接1: 接头, M12, L 型, 插座, A-编码, 4 个引脚 圆接头, LED: 否 连接2: 开口端 有屏蔽: 否 电缆长度: 5,000 mm 护套材料: PVC

紧固系统 - 安装支架

	配件编号	名称	配件	说明
	50124651	BT 205M-10SET	安装设备设置	包含: 10 件 安装设备设计: L 型角度 设备侧固定件: 通孔安装 装置侧固定件: 螺旋式 安装设备类型: 刚性 材料: 金属
	50040269	BT 25	安装设备	安装设备设计: L 型角度 设备侧固定件: 通孔安装 装置侧固定件: 螺旋式 安装设备类型: 刚性 材料: 金属

紧固系统 - 固定杆

	配件编号	名称	配件	说明
	50117829	BTP 200M-D12	安装系统	安装设备设计: 防护罩 设备侧固定件: 适于12mm杆 装置侧固定件: 螺旋式 安装设备类型: 可夹紧, 可调节, 旋转, 360 材料: 金属

配件

	配件编号	名称	配件	说明
	50117255	BTU 200M-D12	安装系统	包含: 2 件螺栓 M3 x 16, 2 件垫片, 2 件螺栓 M3 x 20 安装设备设计: 安装系统 设备侧固定件: 适于12mm杆, 板-金属座 装置侧固定件: 螺旋式, 适用于 M3 螺栓 安装设备类型: 可夹紧, 可调节, 旋转, 360 材料: 金属

注意



所有可用配件的列表请见劳易测网站配件详细信息页面的下载选项卡。

接口

IO-Link interface

Sensors in the HRT 25B/L... variant have a dual channel architecture. The IO-Link interface in accordance with specification 1.1.1 (October 2011) is provided on pin 4 (Q1). This allows the devices to be configured quickly and easily and, therefore, cost-effectively. Furthermore, the sensor transmits its process data and makes diagnostic information available through it.

Parallel to the IO-Link communication, the sensor can output the continuous switching signal for object detection on Q2. The IO-Link communication does not interrupt this signal.

IO-Link process data format

(IO-Link 1.1, M-sequence TYPE_2_1)

Output data device (8 bit)

Data bit	Assignment	Meaning
7	Switching output Q1	0 = inactive, 1 = active
6	Switching output Q2	0 = inactive, 1 = active
5	Switching output Q3	0 = inactive, 1 = active (if Q3 not present = 0)
4	Measurement	0 = initialization/teach/deactivation, 1 = running measurement
3	Signal	0 = no signal or signal too weak, 1 = signal ok
2	Warning	0 = no warning, 1 = warning, e.g., weak signal
1	0	Not assigned (initial state = 0)
0	0	Not assigned (initial state = 0)

Device input data

None

Device-specific IODD

At www.leuze.com in the download area for IO-Link sensors you will find the **IODD zip file** with all data required for the installation.

IO-Link parameter documentation

A complete description of the IO-Link parameters is given in the *.html files. Please double-click one of the two language variants: ***IODD*-de.html** for **German** or ***IODD*-en.html** for **English**.

Teach 设置

Sensor adjustment (teach) via teach button

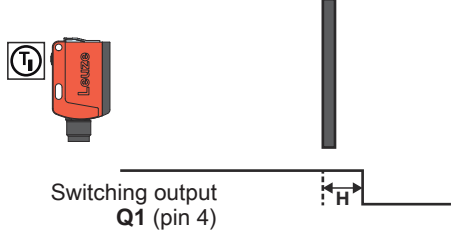
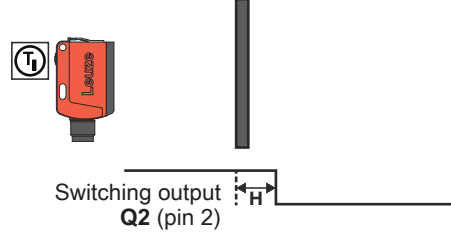
Teach	Operating level 1	Operating level 2
Teaching of two individual switching points	<p>Teach on object for Q1 (pin 4): With this teach mode, the switching distance for switching output Q1 is configured in such a way that the object which is in the beam path during the teach procedure is reliably detected.</p>  <p>Switching output Q1 (pin 4)</p> <p>Hysteresis H: To ensure continuous object detection in the switching point, the sensor has a switch hysteresis. Object is no longer detected if: distance to sensor > teach point + reserve + hysteresis.</p>	<p>Teach on object for Q2 (pin 2): With this teach mode, the switching distance for switching output Q2 is configured in such a way that the object which is in the beam path during the teach procedure is reliably detected.</p>  <p>Switching output Q2 (pin 2)</p>

NOTE



The sensors have a factory-set hysteresis **H** of 50 mm.

Operation via teach button

Teach-in on operating level 1 (switching distance for Q1)

- Press teach button until both LEDs flash simultaneously.
- Release teach button.
- Ready.

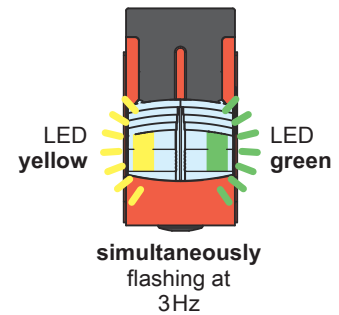
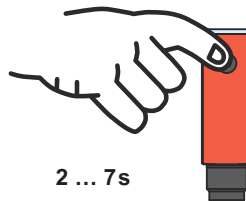

Teach-in on operating level 2 (switching distance for Q2)

- Press teach button until both LEDs flash alternately.
- Release teach button.
- Ready.

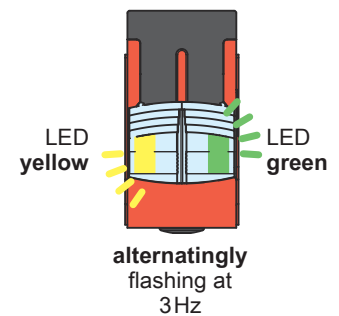
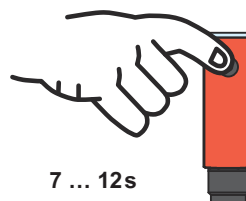

Teach 设置

Adjusting the switching behavior of the switching output – light/dark switching

This function permits inversion of the sensors' switching logic.

- Press teach button until only the green LED flashes. Yellow LED:
ON = switching outputs light switching (in the case of complementary sensors, Q1 (pin 4) light switching, Q2 (pin 2) dark switching), this means output active when object is detected.
- OFF = switching outputs dark switching (in the case of complementary sensors, Q1 (pin 4) dark switching, Q2 (pin 2) light switching), this means output inactive when object is detected.
- Release teach button.
The yellow LED then indicates the toggled switching logic.
- Ready.

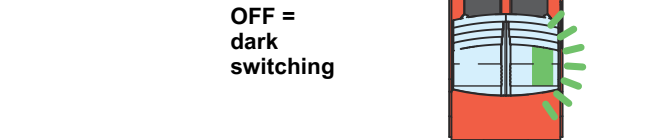
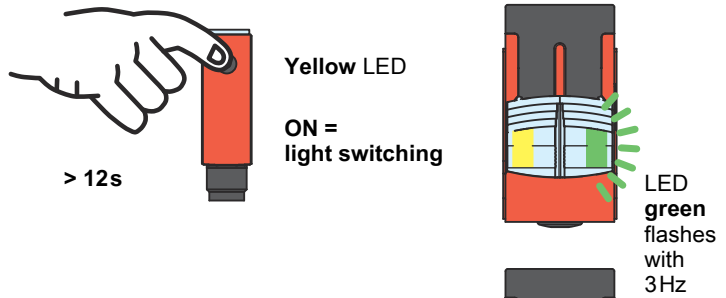

Set factory defaults

It's possible to restore the factory settings of the sensor via the teach button.

- Hold down the teach button during power-on. The green and yellow LEDs flash simultaneously at 3Hz.
- Release the teach button. The green and yellow LEDs flash alternately at 3Hz.
- Press the teach button. The green and yellow LEDs flash simultaneously at 9Hz.
- Release the teach button. The factory settings are restored and the sensor is restarted.

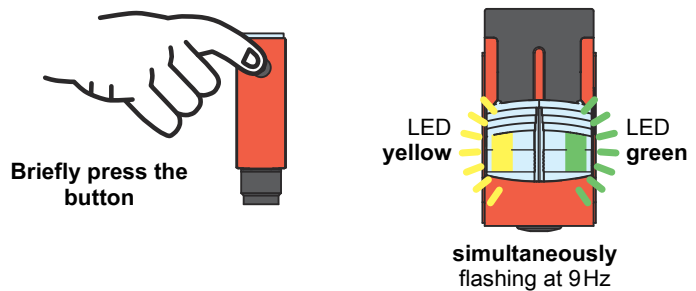
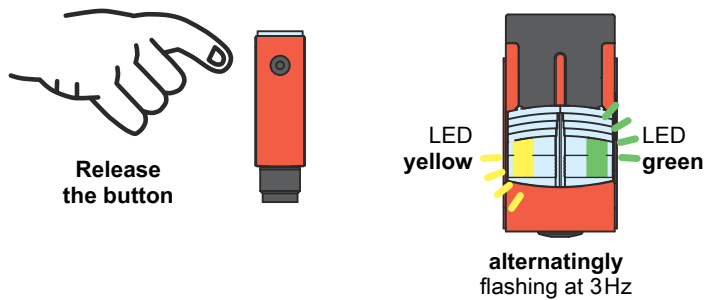
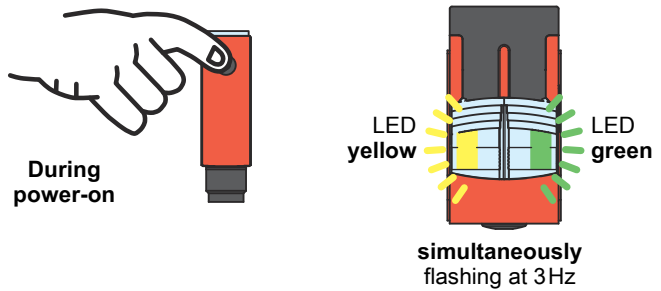

Teach 设置

Sensor adjustment (teach) via teach input (pin 2)

NOTE	
i	<p>The following description applies to PNP switching logic!</p> <p>Signal level LOW $\leq 2V$</p> <p>Signal level HIGH $\geq (U_B - 2V)$</p> <p>With the NPN models, the signal levels are inverted!</p>

Line teach on operating level 1 (switching distance for Q1)

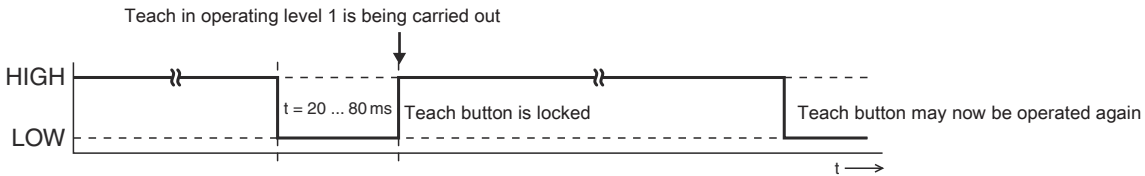

Line teach on operating level 2 (switching distance for Q2)

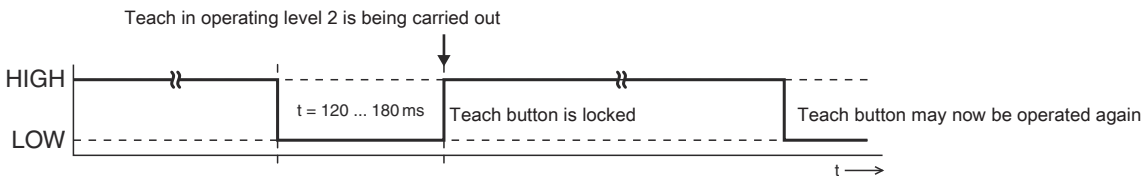

Light switching logic

Switching outputs light switching, this means outputs active when object is detected.
In the case of complementary switching outputs, Q1 (pin 4) light switching, Q2 (pin 2) dark switching.

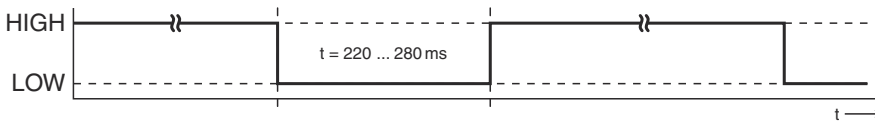

Dark switching logic

Switching outputs dark switching, this means outputs inactive when object is detected.
In the case of complementary switching outputs, Q1 (pin 4) dark switching, Q2 (pin 2) light switching.

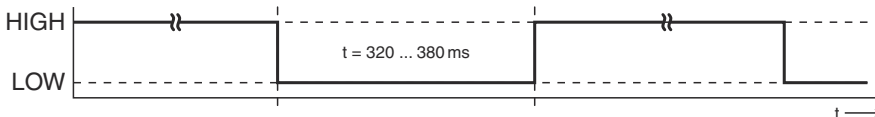

Locking the teach button via teach input (pin 5)

NOTE	
i	<p>A static high signal ($\geq 20 \text{ ms}$) at the teach input locks the teach button on the sensor if required, such that no manual operation is possible (e.g., protection from erroneous operation or manipulation).</p> <p>If the teach input is not connected or if there is a static low signal, the button is unlocked and can be operated freely.</p>

