

## Technical data sheet Bar code positioning system

Part no.: 50125677

BPS 307i SM 100 D H

### Contents

- Technical data
- Dimensioned drawings
- Diagrams
- Part number code
- Notes
- Accessories



For illustration purposes only



## Technical data

### Basic data

Series	BPS 300i
Order guide	Bar code tape must be ordered separately Operation only possible in combination with MS 3xx, MK 3xx or KB 30x connection unit

### Functions

Functions	Heating
-----------	---------

### Characteristic parameters

MTTF	83 years
------	----------

### Optical data

Depth of field	50 ... 170 mm
Light source	Laser, Red
Wavelength	655 nm
Laser class	1, in accordance with IEC 60825-1:2014 (EN 60825-1:2014)
Transmitted-signal shape	Continuous
Light beam exit	Lateral

### Measurement data

Measurement range	0 ... 10,000,000 mm
Resolution	0.01 ... 10 mm
Reproducibility (1 sigma)	0.05 mm
Measurement value output	0.05 ... 2 ms
Max. traverse rate	10 m/s

### Electrical data

Protective circuit	Polarity reversal protection Short circuit protected
--------------------	---

#### Performance data

Supply voltage $U_B$	18 ... 30 V, DC
Power consumption, max.	17.7 W

#### Inputs/outputs selectable

Output current, max.	60 mA
Number of inputs/outputs selectable	2 Piece(s)
Input current, max.	8 mA
Switching element	Transistor, PNP

### Interface

Type	SSI
SSI	
Function	Process
Clock frequency	50 ... 800 kHz
Data bit	Adjustable

### Service interface

Type	USB
USB	
Function	Configuration/parameterization via integrated web server Service

### Mechanical data

Design	Cubic
Dimension (W x H x L)	100 mm x 108.7 mm x 48.3 mm
Housing material	Metal
Metal housing	Diecast aluminum
Lens cover material	Glass
Net weight	580 g
Housing color	Red Silver
Type of fastening	Dovetail grooves Fastening on back Via optional mounting device

### Operation and display

Type of display	LED Monochromatic graphic display, 128 x 32 pixels
Type of configuration	Via web browser

### Environmental data

Ambient temperature, operation	-35 ... 50 °C
Ambient temperature, storage	-35 ... 70 °C
Relative humidity (non-condensing)	90 %

### Certifications

Degree of protection	IP 65, EN 60529 with various connectors or screwed-on caps
Protection class	III
Approvals	c UL US
Test procedure for EMC in accordance with standard	EN 61000-6-2 EN 61000-6-3
Test procedure for shock in accordance with standard	IEC 60068-2-27, test Ea
Test procedure for continuous shock in accordance with standard	IEC 60068-2-29, test Eb
Test procedure for vibration in accordance with standard	IEC 60068-2-6, test Fc

### Classification

Customs tariff number	84719000
ECLASS 5.1.4	27280190
ECLASS 8.0	27280190
ECLASS 9.0	27280190
ECLASS 10.0	27280190
ECLASS 11.0	27280190
ECLASS 12.0	27280106
ECLASS 13.0	27280106
ECLASS 14.0	27280106
ECLASS 15.0	27280106
ECLASS 16.0	27280106
ETIM 5.0	EC001825
ETIM 6.0	EC001825
ETIM 7.0	EC001825
ETIM 8.0	EC001825
ETIM 9.0	EC001825
ETIM 10.0	EC001825
UNSPSC 26.08	39121528

## Dimensioned drawings

All dimensions in millimeters

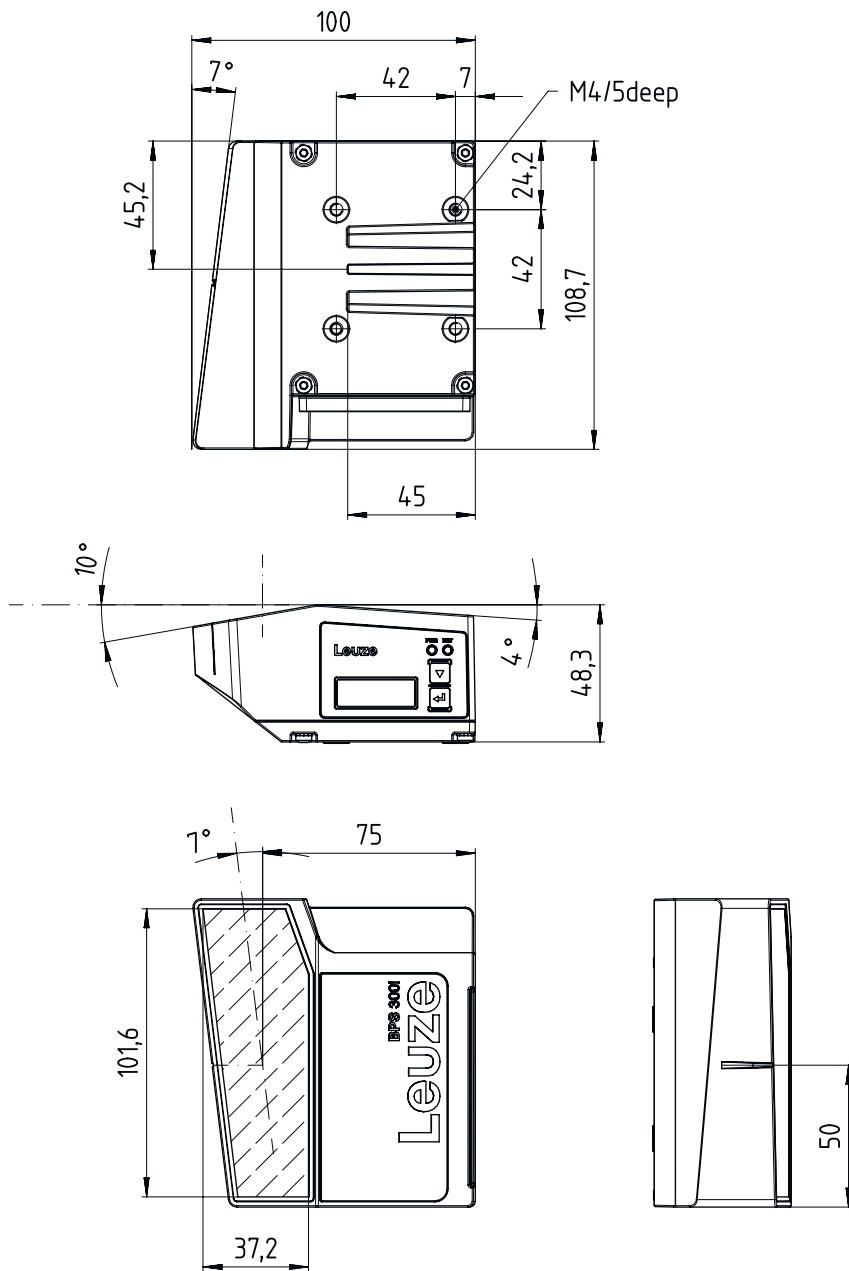

# Diagrams

## Reading field curve

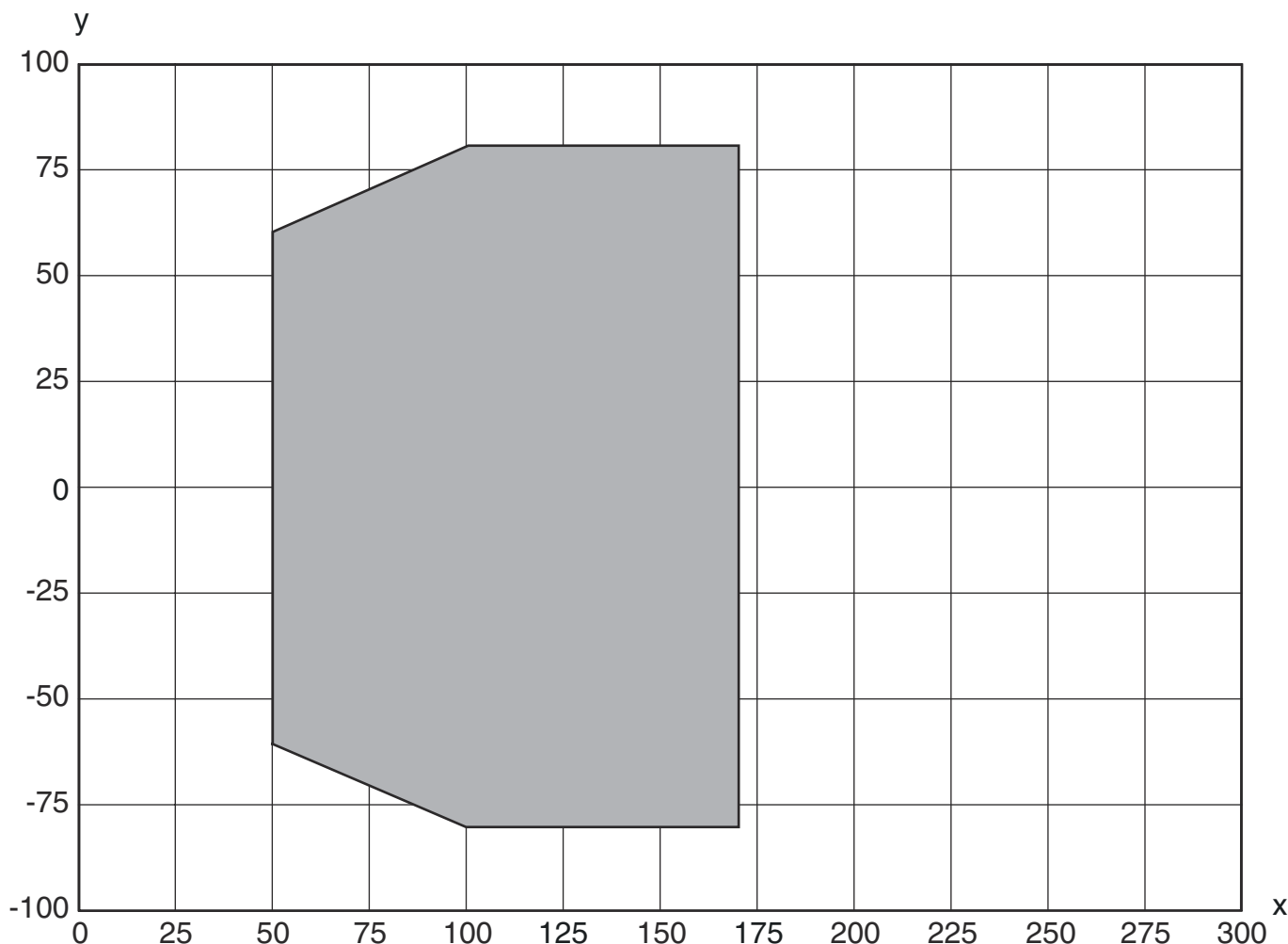

x Reading field distance [mm]  
 y Reading field width [mm]

## Part number code

Part designation: **BPS 3XXi SM 100 Y Z AA**

<b>BPS</b>	<b>Operating principle</b> BPS: bar code positioning system
<b>3XXi</b>	<b>Series/interface (integrated fieldbus technology)</b> 300i: RS 232 / RS 422 (stand-alone) 301i: RS 485 304i: PROFIBUS DP 307i: SSI 348i: PROFINET RT 3007i: SSI (reduced function range) 3048i: PROFINET RT (reduced function range)
<b>SM</b>	<b>Scanning principle / optics</b> S: line scanner (single line)
<b>100</b>	<b>Beam exit</b> 100: lateral

## Part number code

YZ	<b>Special equipment</b> n/a: no special equipment D: With display H: with heating D H: optionally with display and heating
AA	<b>Switching element</b> n/a: Transistor, PNP 02: Transistor, NPN

Note	
	↪ A list with all available device types can be found on the Leuze website at <a href="http://www.leuze.com">www.leuze.com</a> .

## Notes

⚠ Observe intended use!	
	↪ This product is not a safety sensor and is not intended as personnel protection. ↪ The product may only be put into operation by competent persons. ↪ Only use the product in accordance with its intended use.

⚠ ATTENTION! LASER RADIATION – CLASS 1 LASER PRODUCT	
	The device satisfies the requirements of IEC/EN 60825-1:2014 safety regulations for a product of <b>laser class 1</b> and complies with 21 CFR 1040.10 except for conformance with IEC 60825-1 Ed. 3., as described in Laser Notice No. 56, dated May 8, 2019. ↪ Observe the applicable statutory and local laser protection regulations. ↪ The device must not be tampered with and must not be changed in any way. There are no user-serviceable parts inside the device. Repairs must only be performed by Leuze electronic GmbH + Co. KG.

## Accessories

### Connection technology - Connection cables

	Part no.	Designation	Article	Description
	50104172	KB SSI/IBS-2000-BA	Connection cable	Application: Oil and lubricant resistant Suitable for interface: SSI, Interbus-S Connection 1: Connector, M12, Axial, Female, B-coded, 5 -pin Connector, LED: No Connection 2: Open end Shielded: Yes Cable length: 2,000 mm Sheathing material: PUR
	50132077	KD U-M12-5A-V1-020	Connection cable	Application: Chemical resistant Connection 1: Connector, M12, Axial, Female, A-coded, 5 -pin Connector, LED: No Connection 2: Open end Shielded: No Cable length: 2,000 mm Sheathing material: PVC

## Accessories

	Part no.	Designation	Article	Description
	50132079	KD U-M12-5A-V1-050	Connection cable	Application: Chemical resistant Connection 1: Connector, M12, Axial, Female, A-coded, 5 -pin Connector, LED: No Connection 2: Open end Shielded: No Cable length: 5,000 mm Sheathing material: PVC

## Connection technology - Interconnection cables



	Part no.	Designation	Article	Description
	50126132 *	KB 307-3000	Interconnection cable	Suitable for interface: SSI Parameter memory: No Connection 1: Socket connector Connection 2: Socket connector, 10 -pin, 6 -pin Shielded: Yes Cable length: 3,000 mm Sheathing material: PVC

\* Necessary accessories, please order separately

## Connection technology - Connectors

	Part no.	Designation	Article	Description
	50020501	KD 095-5A	Connector	Connection: Connector, M12, Axial, Female, A-coded, 5 -pin

## Connection technology - Connection boxes

	Part no.	Designation	Article	Description
	50126131 *	MK 307	Connection unit	Suitable for: BPS 307i Parameter memory: Yes Number of connections: 3 Piece(s) Connection: Terminal
	50126130 *	MS 307	Connection unit	Suitable for: BPS 307i Parameter memory: Yes Number of connections: 3 Piece(s) Connection: Connector, M12

\* Necessary accessories, please order separately

## Accessories



### Mounting technology - Rod mounts

	Part no.	Designation	Article	Description
	50027375	BT 56	Mounting device	Functions: Static applications Design of mounting device: Mounting system Fastening, at system: For 16 mm rod, For 18 mm rod, For 20 mm rod Mounting bracket, at device: Clampable Material: Metal Tightening torque of the clamping jaws: 8 N·m

### Mounting technology - Other

	Part no.	Designation	Article	Description
	50124941	BTU 0300M-W	Mounting device	Fastening, at system: Through-hole mounting Mounting bracket, at device: Clampable, Groove mounting, Suited for M4 screws Material: Metal Shock absorber: No

### Bar code tape

	Part no.	Designation	Article	Description
	50144190	BCB G40 H25 L010	Bar code tape	Dimensions: 25 mm x 10,000 mm Grid dimension: 40 mm Material: Polyester Manufacturing process for bar code tape: Digital printing
	50040041	BCB G40 H47 L010	Bar code tape	Dimensions: 47 mm x 10,000 mm Grid dimension: 40 mm Material: Polyester Manufacturing process for bar code tape: Digital printing

### Services

	Part no.	Designation	Article	Description
	S981001	CS10-S-110	Start-up support	Details: Performed at location of customer's choosing, duration: max. 10 hours. Conditions: Devices and connection cables are already mounted, price not including travel costs and, if applicable, accommodation expenses.
	S981005	CS10-T-110	Product training	Details: Location and content to be agreed upon, duration: max. 10 hours. Conditions: Price not including travel costs and, if applicable, accommodation expenses.

#### Note



A list with all available accessories can be found on the Leuze website in the Download tab of the article detailed page.