

## Technical data sheet

### Throughbeam photoelectric sensor transmitter

Part no.: 50138585

LS15/XX-M12



For illustration purposes only

#### Contents

- Technical data
- Dimensioned drawings
- Electrical connection
- Diagrams
- Operation and display
- Suitable receivers
- Part number code
- Notes
- Further information
- Accessories



## Technical data

### Basic data

Series	15
Operating principle	Throughbeam principle
Device type	Transmitter

### Optical data

Operating range	0 ... 25 m
Operating range	Guaranteed operating range
Operating range limit	0 ... 30 m
Operating range limit	Typical operating range
Light source	LED, Red
Wavelength	640 nm
Transmitted-signal shape	Pulsed
LED group	Exempt group (in acc. with EN 62471)

### Electrical data

Protective circuit	Polarity reversal protection
	Short circuit protected

### Performance data

Supply voltage $U_B$	10 ... 30 V, DC, Incl. residual ripple
Residual ripple	0 ... 15 %, From $U_B$
Open-circuit current	0 ... 20 mA

### Time behavior

Readiness delay	300 ms
-----------------	--------

### Connection

#### Connection 1

Function	Voltage supply
Type of connection	Connector
Thread size	M12
Type	Male
Material	Plastic
No. of pins	4 -pin
Encoding	A-coded

### Mechanical data

Dimension (W x H x L)	15 mm x 42.7 mm x 30 mm
Housing material	Plastic
Plastic housing	ABS
Lens cover material	Plastic
Net weight	15 g
Housing color	Black
Type of fastening	Through-hole mounting Via optional mounting device

### Operation and display

Type of display	LED
Number of LEDs	2 Piece(s)

### Environmental data

Ambient temperature, operation	-40 ... 60 °C
Ambient temperature, storage	-40 ... 70 °C

### Certifications

Degree of protection	IP 67
Protection class	III
Approvals	c UL US
Standards applied	IEC 60947-5-2

### Classification

Customs tariff number	85365019
ECLASS 5.1.4	27270901
ECLASS 8.0	27270901
ECLASS 9.0	27270901
ECLASS 10.0	27270901
ECLASS 11.0	27270901
ECLASS 12.0	27270901
ECLASS 13.0	27270901
ECLASS 14.0	27270901
ECLASS 15.0	27270901
ETIM 5.0	EC002716
ETIM 6.0	EC002716
ETIM 7.0	EC002716
ETIM 8.0	EC002716
ETIM 9.0	EC002716
ETIM 10.0	EC002716

# Dimensioned drawings

All dimensions in millimeters

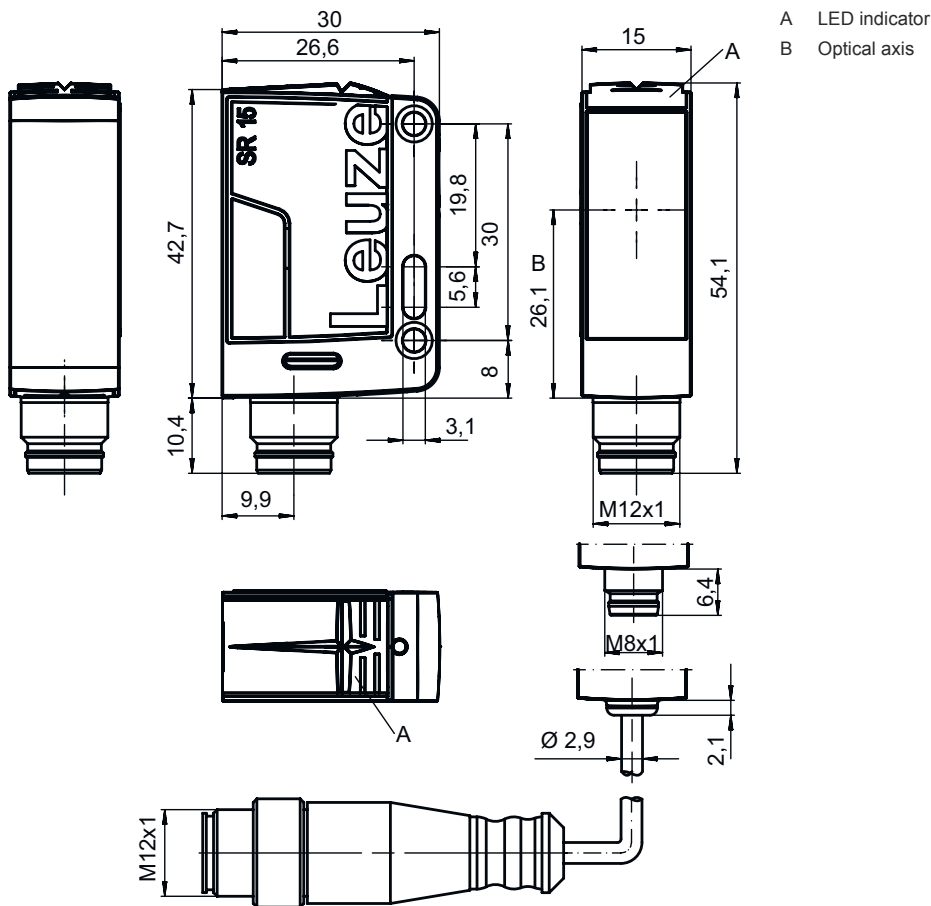

## Electrical connection

### Connection 1

Function	Voltage supply
Type of connection	Connector
Thread size	M12
Type	Male
Material	Plastic
No. of pins	4 -pin
Encoding	A-coded

Pin	Pin assignment
1	V+
2	n.c.
3	GND
4	n.c.

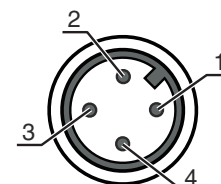

# Diagrams

## Typ. response behavior

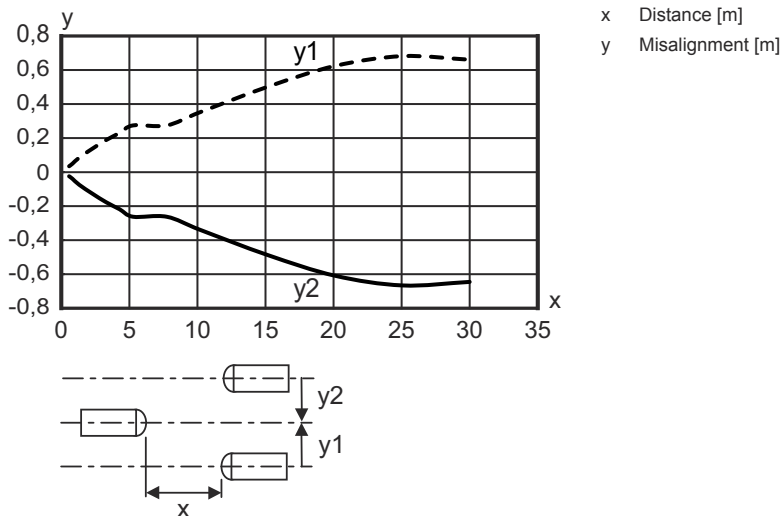

## Operation and display

LED	Display	Meaning
1	Yellow, continuous light	Object detected
2	Green, continuous light	Operational readiness

## Suitable receivers

	Part no.	Designation	Article	Description
	50138589	LE15/2X-M12	Throughbeam photoelectric sensor receiver	Operating range limit: 0 ... 30 m Supply voltage: DC Digital switching outputs: 1 Piece(s) Switching output 1: Transistor, NPN, Light switching Switching frequency: 500 Hz Connection: Connector, M12, Plastic, 4 -pin
	50138588	LE15/4X-M12	Throughbeam photoelectric sensor receiver	Operating range limit: 0 ... 30 m Supply voltage: DC Digital switching outputs: 1 Piece(s) Switching output 1: Transistor, PNP, Light switching Switching frequency: 500 Hz Connection: Connector, M12, Plastic, 4 -pin

## Part number code

Part designation: AAA15d.EE/ ff-HH

<b>AAA15</b>	<b>Operating principle / construction</b> HT15: diffuse reflection sensor with background suppression PRK15: retro-reflective photoelectric sensor with polarization filter LS15: throughbeam photoelectric sensor transmitter LE15: throughbeam photoelectric sensor receiver
<b>d</b>	<b>Light type</b> n/a: red light l: infrared light



## Part number code

<b>EE</b>	<b>Equipment</b> 1: adjustable range D: Detection of stretch-wrapped objects
<b>ff</b>	<b>Switching output / Function</b> 2: NPN transistor output, light switching N: NPN transistor output, dark switching 4: PNP transistor output, light switching P: PNP transistor output, dark switching X: pin not used
<b>HH</b>	<b>Electrical connection</b> n/a: cable, standard length 2000 mm, 3-wire M8: M8 connector, 4-pin (plug) 200-M12: cable, length 200 mm with M12 connector, 4-pin, axial (plug) M12: M12 connector, 4-pin (plug)

### Note

	↪ A list with all available device types can be found on the Leuze website at <a href="http://www.leuze.com">www.leuze.com</a> .
--	--

## Notes



 <b>Observe intended use!</b>	
	↪ This product is not a safety sensor and is not intended as personnel protection. ↪ The product may only be put into operation by competent persons. ↪ Only use the product in accordance with its intended use.

## Further information

- Light source: Average life expectancy 100,000 h at an ambient temperature of 25 °C

## Accessories

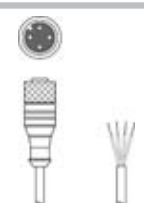
### Connection technology - Connection cables



	Part no.	Designation	Article	Description
	50130652	KD U-M12-4A-V1-050	Connection cable	Connection 1: Connector, M12, Axial, Female, A-coded, 4 -pin Connector, LED: No Connection 2: Open end Shielded: No Cable length: 5.000 mm Sheathing material: PVC
	50130690	KD U-M12-4W-V1-050	Connection cable	Connection 1: Connector, M12, Angled, Female, A-coded, 4 -pin Connector, LED: No Connection 2: Open end Shielded: No Cable length: 5.000 mm Sheathing material: PVC

## Accessories

### Mounting technology - Mounting brackets

	Part no.	Designation	Article	Description
	50040269	BT 25	Mounting device	Design of mounting device: Angle, L-shape Fastening, at system: Through-hole mounting Mounting bracket, at device: Screw type Type of mounting device: Rigid Material: Metal

### Mounting technology - Rod mounts

	Part no.	Designation	Article	Description
	50117829	BTP 200M-D12	Mounting system	Design of mounting device: Protection hood Fastening, at system: For 12 mm rod Mounting bracket, at device: Screw type Type of mounting device: Clampable, Adjustable, Turning, 360° Material: Metal
	50117255	BTU 200M-D12	Mounting system	Design of mounting device: Mounting system Fastening, at system: For 12 mm rod, Sheet-metal mounting Mounting bracket, at device: Screw type, Suited for M3 screws Type of mounting device: Clampable, Adjustable, Turning, 360° Material: Metal

#### Note



A list with all available accessories can be found on the Leuze website in the Download tab of the article detailed page.