

Technical data sheet

Deflecting mirror

Part no.: 529618

UM60-1800

Contents

- Technical data
- Dimensioned drawings



For illustration purposes only

Technical data

Basic data

Series	UM
Type, columns and mirrors	Deflecting mirror on the rear side

Mechanical data

Dimension (W x H x L)	25 mm x 68 mm x 1,870 mm
Net weight	3,420 g
Housing color	Yellow, RAL 1021
Type of fastening	Groove mounting Swivel mount
Suitable for sensor	MLC 500, MLC 300 safety light curtains
Protected field height up to	1,800 mm
Mirror length	1,860 mm

Classification

Customs tariff number	70099200
ECLASS 5.1.4	27279207
ECLASS 8.0	27279207
ECLASS 9.0	27273605
ECLASS 10.0	27273605
ECLASS 11.0	27273605
ECLASS 12.0	27273605
ECLASS 13.0	27273605
ECLASS 14.0	27273605
ECLASS 15.0	27273605
ECLASS 16.0	27273605
ETIM 5.0	EC002467
ETIM 6.0	EC002467
ETIM 7.0	EC002467
ETIM 8.0	EC002467
ETIM 9.0	EC002467
ETIM 10.0	EC002467
UNSPSC 26.08	31241706

Dimensioned drawings

All dimensions in millimeters

Mirror

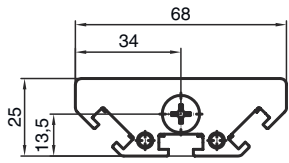

L Length = 1870 mm
SL Mirror length = 1860 mm

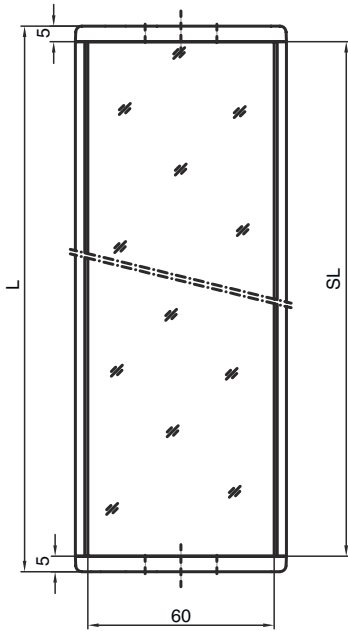

Mounting distances

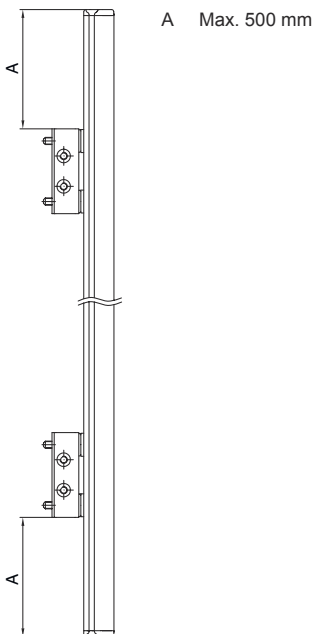

Dimensioned drawings

Mounting with BT-UM60 standard bracket



- A Lateral
- B Rear side
- C Adjustable at an angle (0 - 90°)

Dimensioned drawings

Mounting with BT-SSD swiveling mounting bracket

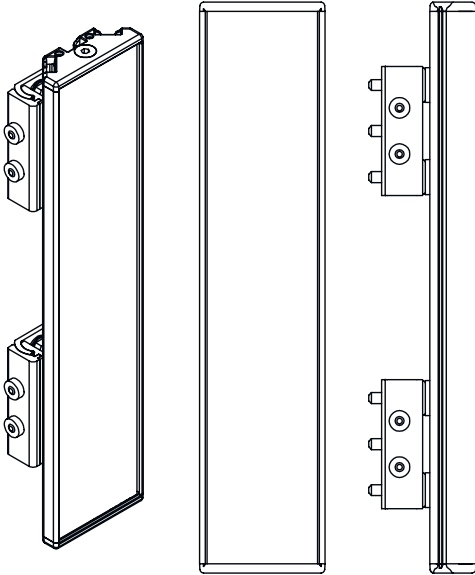
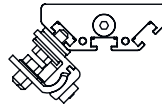
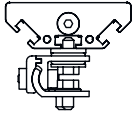

A

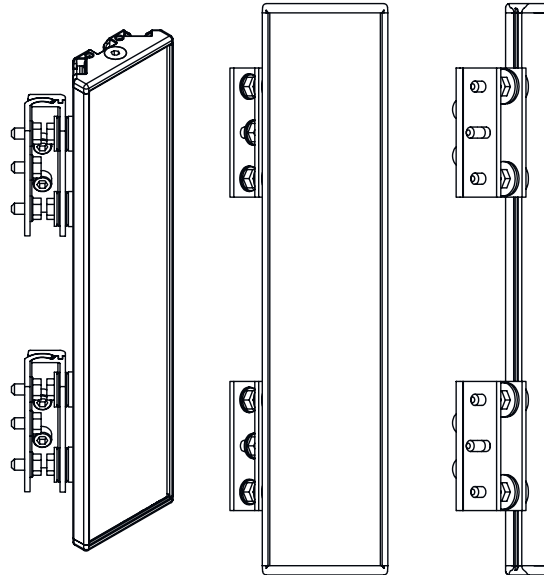

B

- A Rear side
- B Lateral 45°