

Technisch gegevensblad

Sensor achtergrondonderdrukking

Art.-nr.: 50142302

HRT 25B/L6T.32-2500-S12



Afbeelding kan afwijken

Inhoud

- Technische gegevens
- Maattekeningen
- Elektrische aansluiting
- Diagrammen
- Bediening en display
- Artikelsleutel
- Opmerkingen
- Meer informatie
- Toebehoren

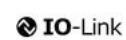

Technische gegevens

Basisgegevens

Serie	25B
Werkingsprincipe	Tastprincipe met achtergrondonderdrukking

Speciale uitvoering

Speciale uitvoering	2 onafhankelijke schakeluitgangen
	Teach via IO-Link
	Teach-ingang

Optische gegevens

Bedrijfsbereik	0,05 ... 2,5 m (gegarandeerd bereik)
Bereiklimiet	0,05 ... 3 m (typisch bereik)
Straalverloop	divergerend
Lichtbron	LED, infrarood
Golflengte	850 nm
Zendsignaalvorm	gepulst
LED-groep	Vrije groep (volgens EN 62471)
Lichtvlek grootte [bij sensorafstand]	60 mm [1.000 mm]
Type lichtvlekgeometrie	rond

Meetgegevens

Herhalingsnauwkeurigheid	$\pm 15\text{ mm}$, voor meetbereik 50 - 2500 mm, afhankelijk van de luminantiefactor en de afstand tot het object, bij 20 °C na opwarmtijd van 20 minuten, gemiddeld bereik U_B , meetobject $\geq 50 \times 50\text{ mm}^2$
Instelnaauwkeurigheid (via IO-Link)	$\pm 10\%$ (300 - 2500 mm)
Temperatuurdrijf	2 mm/K
Zwart/wit-gedrag	25 mm, Luminantiefactor 2 - 90%

Elektrische gegevens

Bluscircuit	Kortsluitbeveiliging
	Ompoolbeveiliging
	Transiëntenbeveiliging

Prestatiegegevens

Voedingsspanning U_B	18 ... 30 V, DC
Restdrempel	0 ... 15 %, van U_B
Nullaststroom	0 ... 32 mA

Ingangen

Aantal teach-ingangen	1 St.
-----------------------	-------

Teach-ingangen

Type	Teach-ingang
Spanningstype	DC
Vertraging	20 ms
Ingangsweerstand	10.000 Ω

Teach-ingang 1

Toewijzing	Aansluiting 1, pin 5
------------	----------------------

Uitgangen

Aantal digitale schakeluitgangen	2 St.
----------------------------------	-------

Schakeluitgangen

Type	Digitale schakeluitgang
Spanningstype	DC
Schakelstroom, max.	50 mA
Schakelspanning	hoog: $\geq (U_B - 2V)$ low: $\leq 2 V$

Schakeluitgang 1

Schakelement	Transistor, Push-pull
Schakelprincipe	IO-Link / lichtschakelend (PNP)/ donkerschakelend (NPN)

Schakeluitgang 2

Schakelement	Transistor, Push-pull
Schakelprincipe	lichtschakelend (PNP)/ donkerschakelend (NPN)

Tijdgedrag

Schakelfrequentie	2 ... 30 Hz, Afhankelijk van remissiegraad
Aanspreektijd	70 ms, Afhankelijk van remissiegraad
Gereedheidsvertraging	300 ms

Interface

Type	IO-Link
------	---------

IO-Link

COM-modus	COM2
Min. cycle time	COM2 = 2,3 ms
Frametype	2.1
Specificatie	V1.1.1
SIO-modus support	Ja
Dual Channel	Ja

Aansluiting

Aantal aansluitingen	1 St.
----------------------	-------

Aansluiting 1

Functie	Signaal IN
	Signaal OUT
	Spanningsvoorziening
Type aansluiting	Ronde stekker
Schroefdraadmaat	M12
Type	male
Materiaal	Kunststof
Aantal polen	5 -polig
Codering	A-gecodeerd

Mechanische gegevens

Afmeting (b x h x l)	15 mm x 38,9 mm x 28,7 mm
Materiaal behuizing	Kunststof
Behuizing kunststof	PC-ABS
Materiaal optiekafdekking	Kunststof / PMMA
Nettogewicht	15 g
Kleur behuizing	Rood
Type bevestiging	Doorgaande bevestiging via optioneel bevestigingsonderdeel
Aanbevolen aandraaimoment voor bevestiging M3	0,9 N·m
Aanbevolen aandraaimoment voor bevestiging M4	1,4 N·m

Bediening en display

Type weergave	LED
Aantal LED's	3 St.
Bedieningselementen	Teach-knop
Functie van bedieningselement	Scanafstandsinstelling

Technische gegevens

Omgevingsgegevens

Omgevingstemperatuur bedrijf	-30 ... 50 °C
Omgevingstemperatuur opslag	-40 ... 60 °C

Certificeringen

Beschermingsgraad	IP 66
	IP 67
Beschermingsgraad	III
Goedkeuringen	c UL US
Geldige norm	IEC 60947-5-2

Classificatie

Douanetariefnnummer	85365019
ECLASS 5.1.4	27270904
ECLASS 8.0	27270904
ECLASS 9.0	27270904
ECLASS 10.0	27270904
ECLASS 11.0	27270904
ECLASS 12.0	27270903
ECLASS 13.0	27270903
ECLASS 14.0	27270903
ECLASS 15.0	27270903
ECLASS 16.0	27270903
ETIM 5.0	EC002719
ETIM 6.0	EC002719
ETIM 7.0	EC002719
ETIM 8.0	EC002719
ETIM 9.0	EC002719
ETIM 10.0	EC002719

Maattekeningen

Alle maten in millimeter

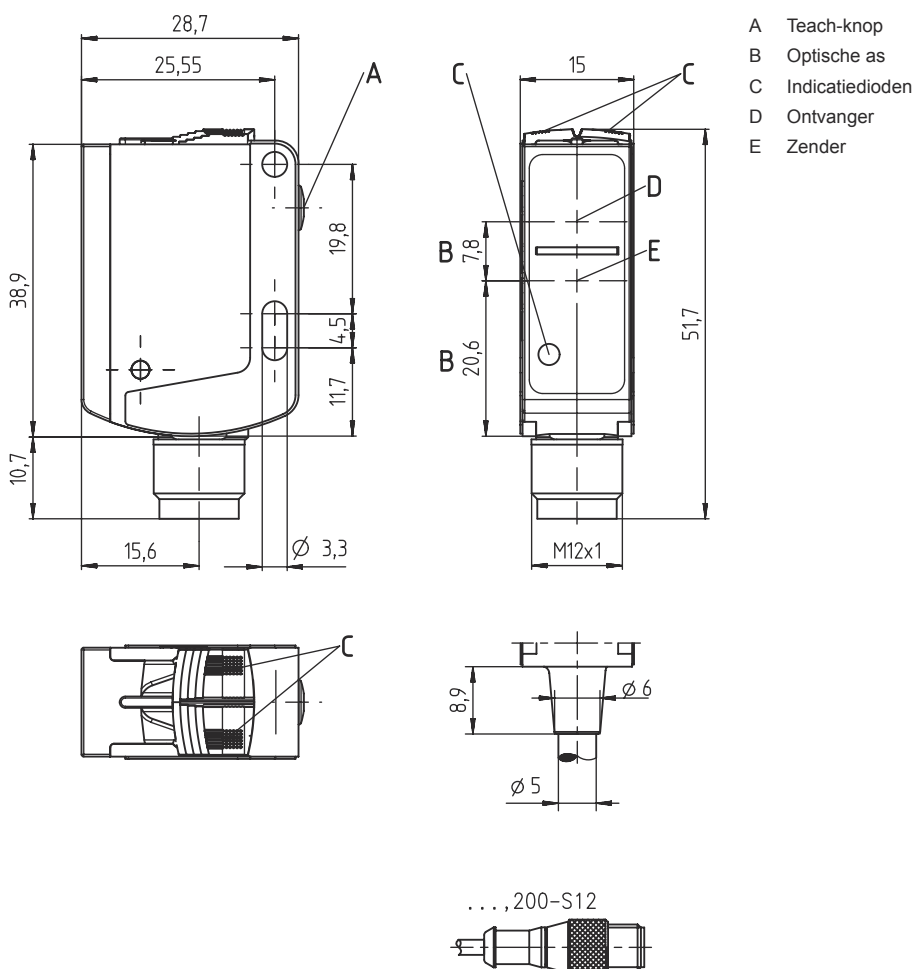

Elektrische aansluiting

Aansluiting 1

Functie	Signaal IN
	Signaal OUT
	Spanningsvoorziening
Type aansluiting	Ronde stekker
Schroefdraadmaat	M12
Type	male
Materiaal	Kunststof
Aantal polen	5 -polig
Codering	A-gecodeerd

Pin Pintoewijzing

Pin	Pintoewijzing
1	V+
2	OUT 2
3	GND
4	IO-Link / OUT 1
5	IN 1

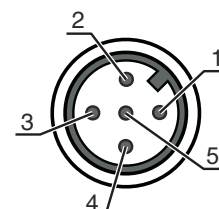

Diagrammen

Typisch aanspreekgedrag

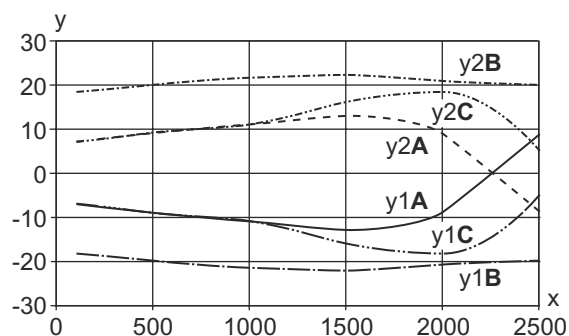

x Afstand [mm]

y Verzet [mm]

y1/2A Object: wit, achtergrond: wit

y1/2B Object: wit, achtergrond: zwart

y1/2C Object: zwart, achtergrond: zwart

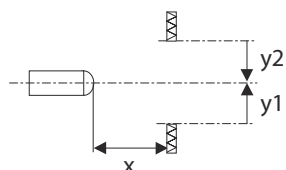

Zwart-/wit-gedrag

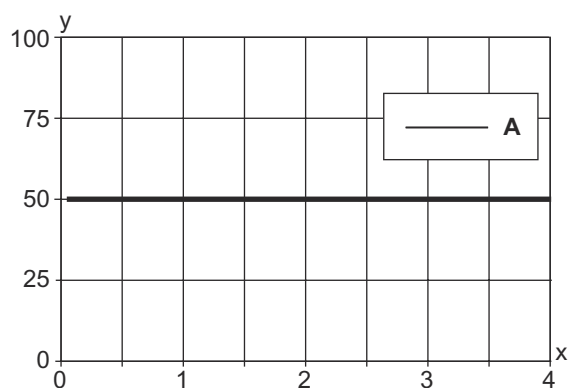

x Tastafstand [mm]

y Typ. tastafstandswijziging [mm], referentie: wit 90%

A Luminantiefactor 4 ... 90%

Bediening en display

LED	Display	Verklaring
1	groen, permanent aan	Bedrijfsgereedheid
2	geel, permanent aan	Object herkend (schakeluitgang Q1)
3	geel, permanent aan	Object herkend (schakeluitgang Q1)
	blauw, permanent aan	Object herkend (schakeluitgang Q2)
	wit, permanent aan	Object herkend (schakeluitgang Q1 en Q2)

Artikelsleutel

Artikelaanduiding: **AAA25B d EFG.HHH-i,J**

AAA	Werkingsprincipe / bouwvorm HRT25B: Reflectorlichttaster met achtergrondonderdrukking ODT25B: afstandstaster met achtergrondonderdrukking
d	Lichtsoort Vervalt: rood licht
E	Formaat Pin 4/Ader BK L: IO-Link (bij Dual Channel ook Push/Pull balansschakeling schakeluitgang Q1)

Artikelsleutel

F	Formaat Pin2/Ader WH 6: Push/Pull (push-pull) schakeluitgang Q2
G	Formaat Pin 5/Ader GY 6: Push/Pull (push-pull) schakeluitgang Q3 9: Deactiveringsingang (fabrieksinstelling) of teach-ingang (> 8 VDC, parametrizeerbaar) T: Teach-ingang voor externe teach-in (> 8 VDC, parametrizeerbaar) X: n.c.
HH	Uitrusting 32: Teach-knop voor teach-in inclusief instelling van de tastwijdte via IO-Link
i	Tastafstand [m] xxxx: Max. operationele tastafstand
J	Elektrische aansluiting Niet van toepassing: kabel, lengte 2000 mm met adereindhulzen, 5-aderig -S12: ronde M12-stekkerverbinding, 5-polig ,200-S12: Kabel, lengte 200 mm met ronde M12-stekkerverbinding, 5-polig

Opmerking



Een lijst met alle beschikbare apparaattypen vindt u op de webpagina van Leuze via www.leuze.com.

Opmerkingen



Gebruiken voor het bedoeld gebruik!



- ☞ Het product is geen veiligheidssensor en dient niet voor personenbeveiliging.
- ☞ Het product mag alleen door een bevoegd persoon in bedrijf worden gesteld.
- ☞ Het product uitsluitend gebruiken volgens het bedoeld gebruik.



Bij UL-applicaties:



- ☞ Bij UL-applicaties is het gebruik alleen toegestaan in Class-2-stroomcircuits volgens NEC (National Electric Code).

Meer informatie



- Lichtbron: gemiddelde levensduur 100.000 uur bij omgevingstemperatuur 25°C
- Waarden gelden voor meetbereik 50 ... 2500 mm, afhankelijk van de reflectiegraad en de afstand tot het object, bij 20 °C na opwarmtijd van 20 minuten, gemiddeld bereik U_B , meetobject $\geq 50 \times 50 \text{ mm}^2$.

Toebehoren



Aansluittechniek - aansluitmodule

	Art.-nr.	Benaming	Artikel	Beschrijving
	50144900	MD 798i-11-82/L5-2222	IO-Link master	Stroomopname, max.: 11.000 mA Interface: IO-Link, Automatische protocolherkenning, EtherNet IP, Modbus TCP, PROFINET Aansluitingen: 12 St. Sensoraansluitingen: 8 St. Beschermingsgraad: IP 67, IP 69K, IP 65

Aansluittechniek - aansluitkabels

	Art.-nr.	Benaming	Artikel	Beschrijving
	50130652	KD U-M12-4A-V1-050	Aansluitkabel	Toepassing: Chemicaliënbestendig Aansluiting 1: Ronde stekker, M12, axiaal, female, A-gecodeerd, 4 -polig Ronde stekker, LED: Nee Aansluiting 2: open uiteinde Afgeschermd: Nee Kabellengte: 5.000 mm Materiaal mantel: PVC
	50130690	KD U-M12-4W-V1-050	Aansluitkabel	Toepassing: Chemicaliënbestendig Aansluiting 1: Ronde stekker, M12, gebogen, female, A-gecodeerd, 4 -polig Ronde stekker, LED: Nee Aansluiting 2: open uiteinde Afgeschermd: Nee Kabellengte: 5.000 mm Materiaal mantel: PVC

Bevestigingstechniek - bevestigingshoekprofielen

	Art.-nr.	Benaming	Artikel	Beschrijving
	50124651	BT 205M-10SET	Set bevestigingsonderdeel	omvat: 10 st. Uitvoering van bevestigingsonderdeel: Hoek L-vorm Bevestiging, installatiezijde: Doorgaande bevestiging Bevestiging, apparaatzijde: schroefbaar Type bevestigingsonderdeel: star Materiaal: Metaal
	50040269	BT 25	Bevestigingsonderdeel	Uitvoering van bevestigingsonderdeel: Hoek L-vorm Bevestiging, installatiezijde: Doorgaande bevestiging Bevestiging, apparaatzijde: schroefbaar Type bevestigingsonderdeel: star Materiaal: Metaal

Bevestigingstechniek - bevestigingen voor ronde stangen

	Art.-nr.	Benaming	Artikel	Beschrijving
	50117829	BTP 200M-D12	Montagesysteem	Uitvoering van bevestigingsonderdeel: Beschermpak Bevestiging, installatiezijde: voor ronde stang 12 mm Bevestiging, apparaatzijde: schroefbaar Type bevestigingsonderdeel: klembaar, draaibaar 360°, instelbaar Materiaal: Metaal

Toebehoren

	Art.-nr.	Benaming	Artikel	Beschrijving
	50117255	BTU 200M-D12	Montagesysteem	omvat: 2 st. bout M3 x 16, 2 st. bout M3 x 20, 2 st. onderlegging Uitvoering van bevestigingsonderdeel: Montagesysteem Bevestiging, installatiezijde: voor ronde stang 12 mm, Plaatklembevestiging Bevestiging, apparaatzijde: schroefbaar, Geschikt voor M3-schroeven Type bevestigingsonderdeel: klembaar, draaibaar 360°, instelbaar Materiaal: Metaal

Opmerking

↪ Een lijst met alle beschikbare toebehoren vindt u op de webpagina van Leuze onder het downloadtabblad van de artikeldetailpagina.

Interface

IO-Link interface

Sensors in the HRT 25B/L... variant have a dual channel architecture. The IO-Link interface in accordance with specification 1.1.1 (October 2011) is provided on pin 4 (Q1). This allows the devices to be configured quickly and easily and, therefore, cost-effectively. Furthermore, the sensor transmits its process data and makes diagnostic information available through it.

Parallel to the IO-Link communication, the sensor can output the continuous switching signal for object detection on Q2. The IO-Link communication does not interrupt this signal.

IO-Link process data format

(IO-Link 1.1, M-sequence TYPE_2_1)

Output data device (8 bit)

Data bit	Assignment	Meaning
7	Switching output Q1	0 = inactive, 1 = active
6	Switching output Q2	0 = inactive, 1 = active
5	Switching output Q3	0 = inactive, 1 = active (if Q3 not present = 0)
4	Measurement	0 = initialization/teach/deactivation, 1 = running measurement
3	Signal	0 = no signal or signal too weak, 1 = signal ok
2	Warning	0 = no warning, 1 = warning, e.g., weak signal
1	0	Not assigned (initial state = 0)
0	0	Not assigned (initial state = 0)

Device input data

None

Device-specific IODD

At www.leuze.com in the download area for IO-Link sensors you will find the **IODD zip file** with all data required for the installation.

IO-Link parameter documentation

A complete description of the IO-Link parameters is given in the *.html files. Please double-click one of the two language variants: ***IODD*-de.html** for **German** or ***IODD*-en.html** for **English**.

Teach instellingen

Sensor adjustment (teach) via teach button

Teach	Operating level 1	Operating level 2
Teaching of two individual switching points	<p>Teach on object for Q1 (pin 4):</p> <p>With this teach mode, the switching distance for switching output Q1 is configured in such a way that the object which is in the beam path during the teach procedure is reliably detected.</p> <p>Switching output Q1 (pin 4)</p> <p>Hysteresis H:</p> <p>To ensure continuous object detection in the switching point, the sensor has a switch hysteresis. Object is no longer detected if: distance to sensor > teach point + reserve + hysteresis.</p>	<p>Teach on object for Q2 (pin 2):</p> <p>With this teach mode, the switching distance for switching output Q2 is configured in such a way that the object which is in the beam path during the teach procedure is reliably detected.</p> <p>Switching output Q2 (pin 2)</p>

NOTE



The sensors have a factory-set hysteresis **H** of 50 mm.

Operation via teach button

Teach-in on operating level 1 (switching distance for Q1)

- Press teach button until both LEDs flash simultaneously.
- Release teach button.
- Ready.

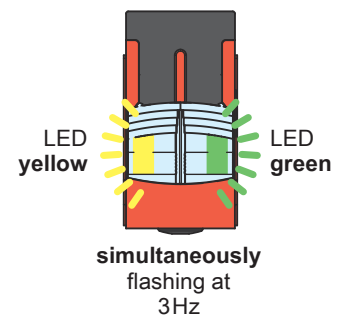
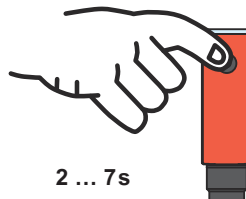

Teach-in on operating level 2 (switching distance for Q2)

- Press teach button until both LEDs flash alternately.
- Release teach button.
- Ready.

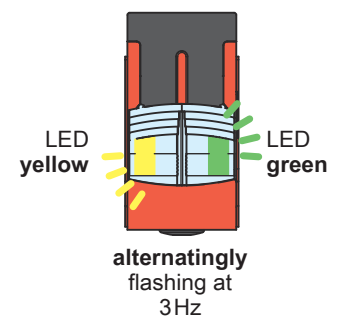
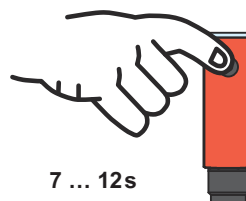

Teach instellingen

Adjusting the switching behavior of the switching output – light/dark switching

This function permits inversion of the sensors' switching logic.

- Press teach button until only the green LED flashes. Yellow LED:
ON = switching outputs light switching (in the case of complementary sensors, Q1 (pin 4) light switching, Q2 (pin 2) dark switching), this means output active when object is detected.
- OFF = switching outputs dark switching (in the case of complementary sensors, Q1 (pin 4) dark switching, Q2 (pin 2) light switching), this means output inactive when object is detected.
- Release teach button.
The yellow LED then indicates the toggled switching logic.
- Ready.

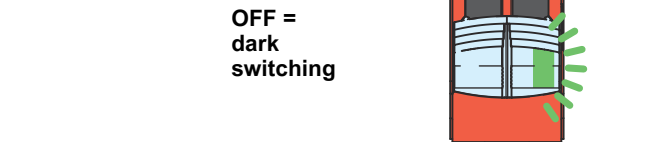
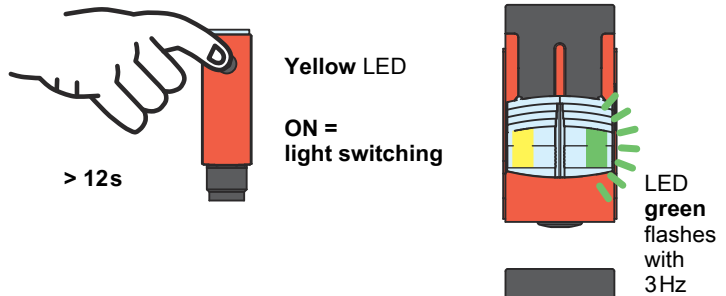

Set factory defaults

It's possible to restore the factory settings of the sensor via the teach button.

- Hold down the teach button during power-on. The green and yellow LEDs flash simultaneously at 3Hz.
- Release the teach button. The green and yellow LEDs flash alternately at 3Hz.
- Press the teach button. The green and yellow LEDs flash simultaneously at 9Hz.
- Release the teach button. The factory settings are restored and the sensor is restarted.

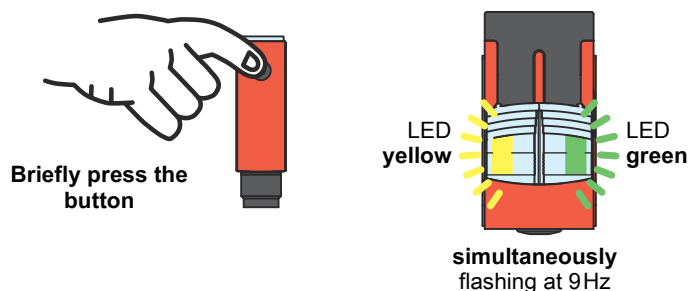
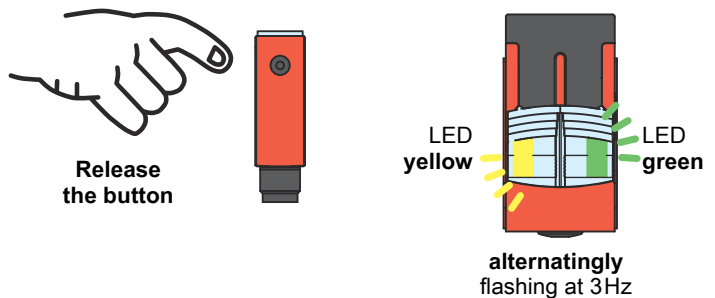
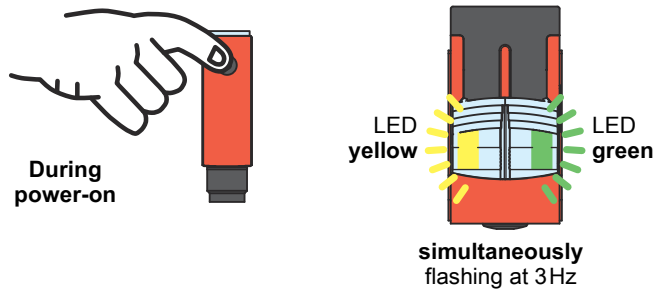

Teach instellingen

Sensor adjustment (teach) via teach input (pin 2)

NOTE	
i	<p>The following description applies to PNP switching logic!</p> <p>Signal level LOW $\leq 2V$</p> <p>Signal level HIGH $\geq (U_B - 2V)$</p> <p>With the NPN models, the signal levels are inverted!</p>

Line teach on operating level 1 (switching distance for Q1)

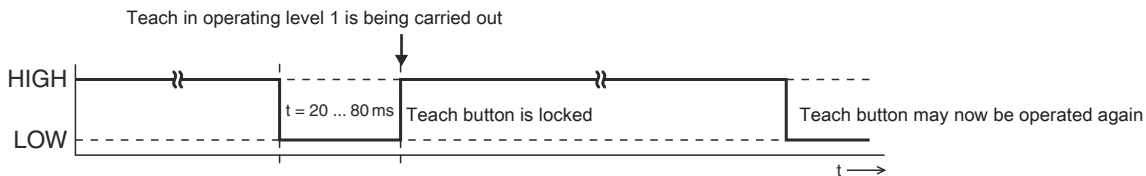

Line teach on operating level 2 (switching distance for Q2)

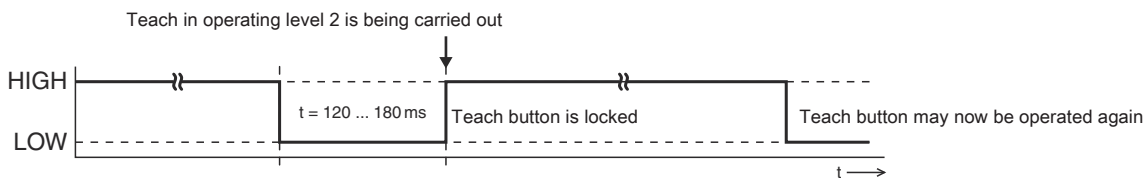

Light switching logic

Switching outputs light switching, this means outputs active when object is detected.
 In the case of complementary switching outputs, Q1 (pin 4) light switching, Q2 (pin 2) dark switching.

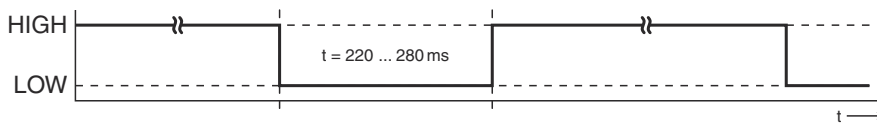

Dark switching logic

Switching outputs dark switching, this means outputs inactive when object is detected.
 In the case of complementary switching outputs, Q1 (pin 4) dark switching, Q2 (pin 2) light switching.

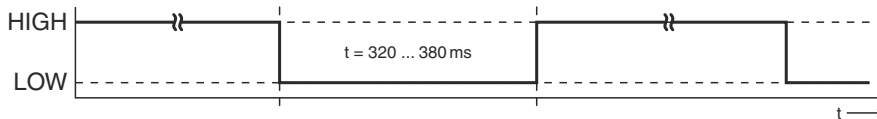

Locking the teach button via teach input (pin 5)

NOTE	
i	<p>A static high signal ($\geq 20ms$) at the teach input locks the teach button on the sensor if required, such that no manual operation is possible (e.g., protection from erroneous operation or manipulation).</p> <p>If the teach input is not connected or if there is a static low signal, the button is unlocked and can be operated freely.</p>

