

## Technical data sheet

### Vision sensor

Part no.: 50147796

IVS 1048i ADJ-8F4-102-M4-TPRD



For illustration purposes only

#### Contents

- Technical data
- Dimensioned drawings
- Electrical connection
- Part number code
- Notes
- Further information
- Accessories



Ethernet



## Technical data

### Basic data

Series	IVS 1000i
Imager	Sony global shutter

### Functions

Software functions	Locate: surface, edge, form Parts detection: brightness, contrast, surface pixels, edge pixels
--------------------	---

### Optical data

Reading distance	50 ... 2,000 mm
Light source	LED, red / white, internally switchable
Transmitted-signal shape	Pulsed
Camera resolution, horizontal	1,440 px
Camera resolution, vertical	1,080 px
Focal length	8 mm
Electronic shutter speed	0.025 ... 2 ms
Camera type	Monochrome

### Electrical data

Protective circuit	Polarity reversal protection Short circuit protected
--------------------	---

#### Performance data

Supply voltage $U_B$	18 ... 30 V, DC
Power consumption, max.	24 W, at 24 V DC

#### Inputs

Number of digital switching inputs	3 Piece(s)
------------------------------------	------------

#### Switching inputs

Voltage type	DC
--------------	----

#### Outputs

Number of digital switching outputs	5 Piece(s)
-------------------------------------	------------

#### Switching outputs

Voltage type	DC
Switching current, max.	100 mA
Switching voltage	high: $\geq(U_B - 2V)$ low: $\leq 2 V$

#### Switching output 1

Switching element	MOSFET semiconductor
Switching principle	Push-pull

#### Switching output 2

Switching element	MOSFET semiconductor
Switching principle	Push-pull

#### Switching output 3

Switching element	MOSFET semiconductor
Switching principle	Push-pull

#### Switching output 4

Switching element	MOSFET semiconductor
Switching principle	Push-pull

### Interface

Type	Ethernet, PROFINET
------	--------------------

### Ethernet

Architecture	Client Server
Address assignment	DHCP Manual address assignment
Transmission speed	10 / 100 Mbit/s
Function	Process
Switch functionality	None
Transmission protocol	TCP/IP, UDP, Telnet, FTP/SFTP, PROFINET

### PROFINET

Function	Process
Conformance class	B
Protocol	PROFINET RT
Transmission speed	100 Mbit/s

### Connection

Number of connections	2 Piece(s)
-----------------------	------------

#### Connection 1

Function	Signal IN Signal OUT Voltage supply
Type of connection	Connector
Thread size	M12
Type	Male
Material	Metal
No. of pins	12 -pin
Encoding	A-coded

#### Connection 2

Function	Data interface Ethernet, input
Type of connection	Connector
Thread size	M12
Type	Female
Material	Metal
No. of pins	8 -pin
Encoding	X-coded

### Mechanical data

Design	Cubic
Dimension (W x H x L)	45 mm x 85 mm x 35 mm
Housing material	Metal
Metal housing	Diecast zinc
Lens cover material	Plastic / PMMA
Net weight	265 g
Housing color	Silver
Type of fastening	Mounting thread Via optional mounting device

### Operation and display

Number of LEDs	3 Piece(s)
Type of configuration	Vision Studio software

### Environmental data

Ambient temperature, operation	0 ... 50 °C
Ambient temperature, storage	-20 ... 70 °C
Relative humidity (non-condensing)	90 %

## Technical data

### Certifications

Degree of protection	IP 67, EN 60529 with various connectors or screwed-on caps
Protection class	III
Approvals	c UL US
Test procedure for EMC in accordance with standard	EN 61000-6-2 EN 61000-6-3
Test procedure for continuous shock in accordance with standard	IEC 60068-2-27, test Ea
Test procedure for vibration in accordance with standard	IEC 60068-2-6, test Fc

### Classification

Customs tariff number	90318020
ECLASS 5.1.4	27310101
ECLASS 8.0	27310101
ECLASS 9.0	27310201
ECLASS 10.0	27310101
ECLASS 11.0	27310101
ECLASS 12.0	27310101
ECLASS 13.0	27310101
ECLASS 14.0	27310101
ECLASS 15.0	27310101
ECLASS 16.0	27310101
ETIM 5.0	EC002550
ETIM 6.0	EC002550
ETIM 7.0	EC002550
ETIM 8.0	EC002550
ETIM 9.0	EC002550
ETIM 10.0	EC002550
UNSPSC 26.08	43211718

# Dimensioned drawings

All dimensions in millimeters

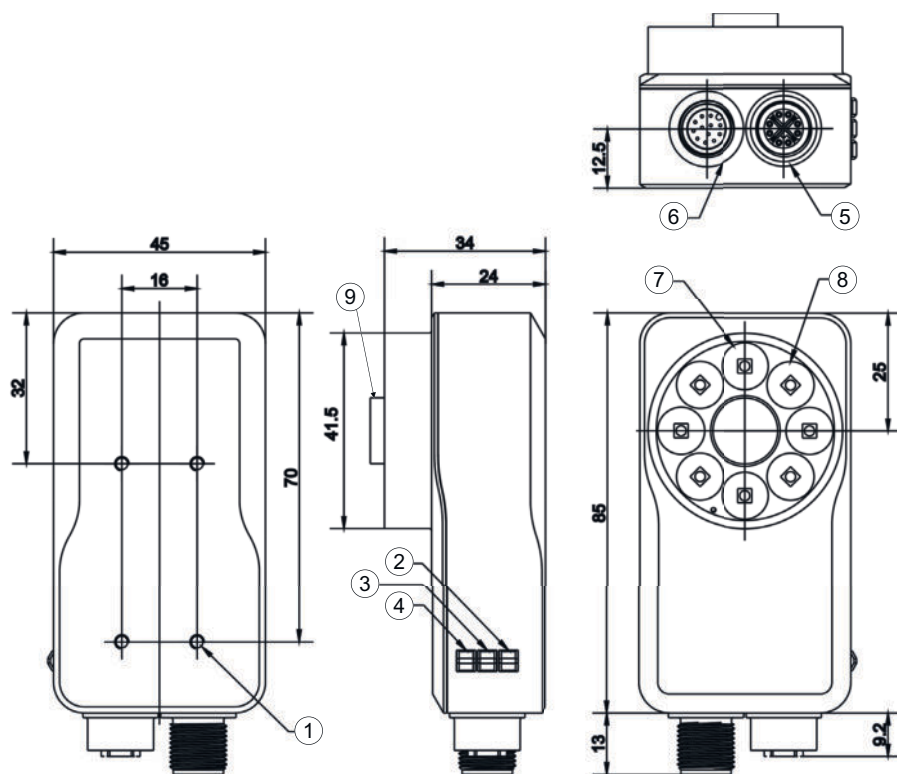

- 1 4 x M3 mounting thread
- 2 Green LED, operation
- 3 Yellow LED, LAN (Ethernet)
- 4 Yellow LED, trigger
- 5 M12 Ethernet connection, X-coded, female
- 6 Connection for operating voltage and I/O, M12, A-coded, 12-pin, male
- 7 Integrated high power LED illumination, red
- 8 Integrated high power LED illumination, white
- 9 Lens

## Electrical connection

### Connection 1

Function	Signal IN Signal OUT Voltage supply
Type of connection	Connector
Thread size	M12
Type	Male
Material	Metal
No. of pins	12 -pin
Encoding	A-coded

Pin	Pin assignment	Conductor color
1	IN 0	Brown
2	IN 1	Blue
3	OUT 2	White
4	OUT 3	Green
5	READY	Pink
6	COMMON INTERFACE	Yellow
7	VIN	Black
8	GND	Gray
9	n.c.	Red
10	Trigger IN	Violet
11	OUT 0	gray / pink
12	OUT 1	red / blue



# Electrical connection

## Connection 2

<b>Function</b>	Data interface
	Ethernet, input
<b>Type of connection</b>	Connector
<b>Thread size</b>	M12
<b>Type</b>	Female
<b>Material</b>	Metal
<b>No. of pins</b>	8 -pin
<b>Encoding</b>	X-coded

Pin	Pin assignment
1	LAN A+
2	LAN A-
3	LAN B+
4	LAN B-
5	LAN D+
6	LAN D-
7	LAN C-
8	LAN C+

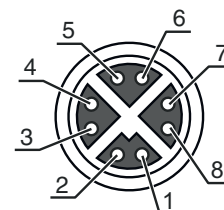

## Part number code

Part designation: IVS XXXXX YYY AAA BBB C D EFFF

<b>IVS</b>	<b>Operating principle</b> IVS: Vision Sensor for inspection tasks
<b>XXXXX</b>	<b>Series/interface (integrated fieldbus technology)</b> 1048i: PROFINET, Ethernet TCP/IP + FTP, SFTP
<b>YYY</b>	<b>Focus position</b> ADJ: adjustable (manually)
<b>AAA</b>	<b>Optics model</b> 8: focal length 8 mm F4: diaphragm f/4.0
<b>BBB</b>	<b>Beam exit</b> 102: front
<b>C</b>	<b>Illumination</b> M: multicolor
<b>D</b>	<b>Resolution range</b> 4: 1440 x 1080 pixels 1: 736 x 480 pixels
<b>E</b>	T: toolset
<b>FFF</b>	<b>Version</b> n/a: 1D/2D-code reading DPM: 1D-, 2D-code reading + DPM (directly marked codes) PRD: presence detection MEC: presence detection, measuring, counting ALL: presence detection, measuring, counting, 1D/2D-code reading + DPM

### Note



A list with all available device types can be found on the Leuze website at [www.leuze.com](http://www.leuze.com).

## Notes

<b>Observe intended use!</b>	
	<ul style="list-style-type: none"> <li>⚡ This product is not a safety sensor and is not intended as personnel protection.</li> <li>⚡ The product may only be put into operation by competent persons.</li> <li>⚡ Only use the product in accordance with its intended use.</li> </ul>

## Further information

- The specified core colors apply when using connection cables from Leuze.

## Accessories

### Connection technology - Connection cables

	Part no.	Designation	Article	Description
	50130282	KD S-M12-CA-P1-050	Connection cable	Application: Oil and lubricant resistant Connection 1: Connector, M12, Axial, Female, A-coded, 12 -pin Connector, LED: No Connection 2: Open end Shielded: Yes Cable length: 5,000 mm Sheathing material: PUR
	50134943	KD S-M12-CW-P1-050	Connection cable	Application: Oil and lubricant resistant Connection 1: Connector, M12, Angled, Female, A-coded, 12 -pin Connector, LED: No Connection 2: Open end Shielded: Yes Cable length: 5,000 mm Sheathing material: PUR

### Connection technology - Interconnection cables

	Part no.	Designation	Article	Description
	50137380	KSS GB-M12-8A-RJ45-A-P7-050	Interconnection cable	Suitable for interface: Ethernet Connection 1: Connector, M12, Axial, Male, X-coded, 8 -pin Connection 2: RJ45 Shielded: Yes Cable length: 5,000 mm Sheathing material: PUR
	50136188	KSS GB-M12-8W-RJ45-A-P7-050	Interconnection cable	Application: Oil and lubricant resistant Suitable for interface: Ethernet Connection 1: Connector, M12, Angled, Male, X-coded, 8 -pin Connection 2: RJ45 Shielded: Yes Cable length: 5,000 mm Sheathing material: PUR

## Accessories

### Mounting technology - Mounting brackets

	Part no.	Designation	Article	Description
	50121433	BT 300 W	Mounting device	Contains: 4x M4 x 10 screw, 2x M6 x 10 screws, 4x M3 x 8 screw Design of mounting device: Angle, L-shape Fastening, at system: Through-hole mounting Mounting bracket, at device: Screw type Type of mounting device: Adjustable Material: Metal

### Mounting technology - Swivel mounts

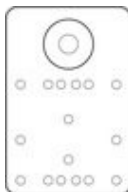
	Part no.	Designation	Article	Description
	50149698	BTK IVS 1048	Mounting device	Fastening, at system: Screw type Mounting bracket, at device: Spherical head Material: Aluminum

## Lenses

	Part no.	Designation	Article	Description
	50148541	Lens S-M12-4F4	Lens	Suitable for: IVS 1000i & DCR 1000i Focal length: 3.6 mm

## Cover hoods

	Part no.	Designation	Article	Description
	50148549	AC IVS 1048-RED	Cover hood	Type of article: Cover hood with bandpass filter for red light Suitable for: IVS 1000i & DCR 1000i Angle of incidence (AOI): 0 ... 15 ° Material: BOROFLOAT®

## Illuminations

	Part no.	Designation	Article	Description
	50148126	IL AL 023/096 RD 301	Illumination	Type of article: LED surface illumination Suitable for: IVS 1000i & DCR 1000i Functions: Triggered operation, Integrated power control Light source: LED, Red Opening angle, max.: 30 ° Housing material: Metal Type of fastening: Via optional mounting device, Groove mounting

# Accessories

	Part no.	Designation	Article	Description
	50148122	IL BA 012/065 RD 301 L D	Illumination	Type of article: LED bar lighting with switchable constant light Suitable for: IVS 1000i & DCR 1000i Special version: Protective cover, lenticular Functions: Continuous operation Light source: LED, Red Opening angle, max.: 18 ° Housing material: Metal Type of fastening: Via optional mounting device, Mounting thread
	50148123	IL BA 012/130 RD 301 L D	Illumination	Type of article: LED bar lighting with switchable constant light Suitable for: IVS 1000i & DCR 1000i Special version: Protective cover, lenticular Functions: Continuous operation Light source: LED, Red Opening angle, max.: 18 ° Housing material: Metal Type of fastening: Via optional mounting device, Mounting thread
	50148124	IL BA 012/240 RD 301 L D	Illumination	Type of article: LED bar lighting with switchable constant light Suitable for: IVS 1000i & DCR 1000i Special version: Protective cover, lenticular Functions: Continuous operation Light source: LED, Red Opening angle, max.: 18 ° Housing material: Metal Type of fastening: Mounting thread, Via optional mounting device
	50148130	IL SP 021/007 300	Illumination	Type of article: LED spotlight Suitable for: IVS 1000i & DCR 1000i Functions: Integrated power control, Triggered operation Light source: LED, Red Opening angle, max.: 7 ° Housing material: Metal Type of fastening: Via optional mounting device, Mounting thread
	50148131	IL SP 021/014 300	Illumination	Type of article: LED spotlight Suitable for: IVS 1000i & DCR 1000i Functions: Triggered operation, Integrated power control Light source: LED, Red Opening angle, max.: 14 ° Housing material: Metal Type of fastening: Mounting thread, Via optional mounting device

**Note**

A list with all available accessories can be found on the Leuze website in the Download tab of the article detailed page.