

Technical data sheet Optical guidance sensor

Part no.: 50137473

OGS 600-140/CN-M12

Contents

- Technical data
- Dimensioned drawings
- Electrical connection
- Diagrams
- Notes
- Accessories



For illustration purposes only

CE CANopen RS232

UL US LISTED

UK CA

Technical data

Basic data

Series	OGS 600
Application	Optical guidance
Trace types	Dark trace on light background
	Light trace on dark background
	Retro-reflective trace

Optical data

Working range	10 ... 70 mm
Light source	LED, Red
Wavelength	634 nm
Transmitted-signal shape	Pulsed
Detection width for complete trace	115 mm

Measurement data

Measurement value resolution	1 mm, Working distance 35 mm
Linearity error	0 ... 5 mm, Working distance 35 mm
Output value for edges	170 ... 1,330
Maximum output value	0 ... 1,500

Electrical data

Protective circuit	Polarity reversal protection
	Short circuit protected

Performance data

Supply voltage U_B	18 ... 30 V, DC
Average power consumption	4 W

Outputs

Number of digital switching outputs	1 Piece(s)
-------------------------------------	------------

Switching outputs

Type	Digital switching output
Voltage type	DC
Switching current, max.	100 mA
Switching voltage	high: $\geq(U_B - 2V)$
	low: $\leq 2 V$

Switching output 1

Switching element	Transistor, PNP
Switching principle	Trace monitoring / contrast monitoring, adjustable

Time behavior

Cycle time	10 ms
------------	-------

Interface

Type	CANopen
CANopen	
Function	Process
Transmission speed	10 ... 1,000 kBit/s

Service interface

Type	RS 232
RS 232	
Transmission speed	115,200 bit/s

Connection

Number of connections	2 Piece(s)
-----------------------	------------

Connection 1

Function	Data interface
Type of connection	Connector
Thread size	M12
Type	Female
Material	Metal
No. of pins	5 -pin
Encoding	A-coded

Connection 2

Function	Service interface
	Signal OUT
	Voltage supply
Type of connection	Connector
Thread size	M12
Type	Male
Material	Metal
No. of pins	5 -pin
Encoding	A-coded

Mechanical data

Design	Cubic
Dimension (W x H x L)	34.5 mm x 47.5 mm x 216 mm
Metal housing	Aluminum
Lens cover material	Plastic
Net weight	245 g
Housing color	Red
Type of fastening	Supplied mounting bracket

Operation and display

Type of configuration	Software
-----------------------	----------

Environmental data

Ambient temperature, operation	-15 ... 50 °C
Ambient temperature, storage	-30 ... 60 °C

Certifications

Degree of protection	IP 65
Protection class	III
Approvals	c UL US
Standards applied	EN 60947-5-2:2007+A1:2012

Technical data

Customs tariff number	85365019
ECLASS 5.1.4	27270906
ECLASS 8.0	27270906
ECLASS 9.0	27270906
ECLASS 10.0	27270906
ECLASS 11.0	27270906
ECLASS 12.0	27270906
ECLASS 13.0	27270906
ECLASS 14.0	27270906
ECLASS 15.0	27270906
ECLASS 16.0	27270906
ETIM 5.0	EC001820
ETIM 6.0	EC001820
ETIM 7.0	EC001820
ETIM 8.0	EC001820
ETIM 9.0	EC001820
ETIM 10.0	EC001820
UNSPSC 26.08	39121528

Dimensioned drawings

All dimensions in millimeters

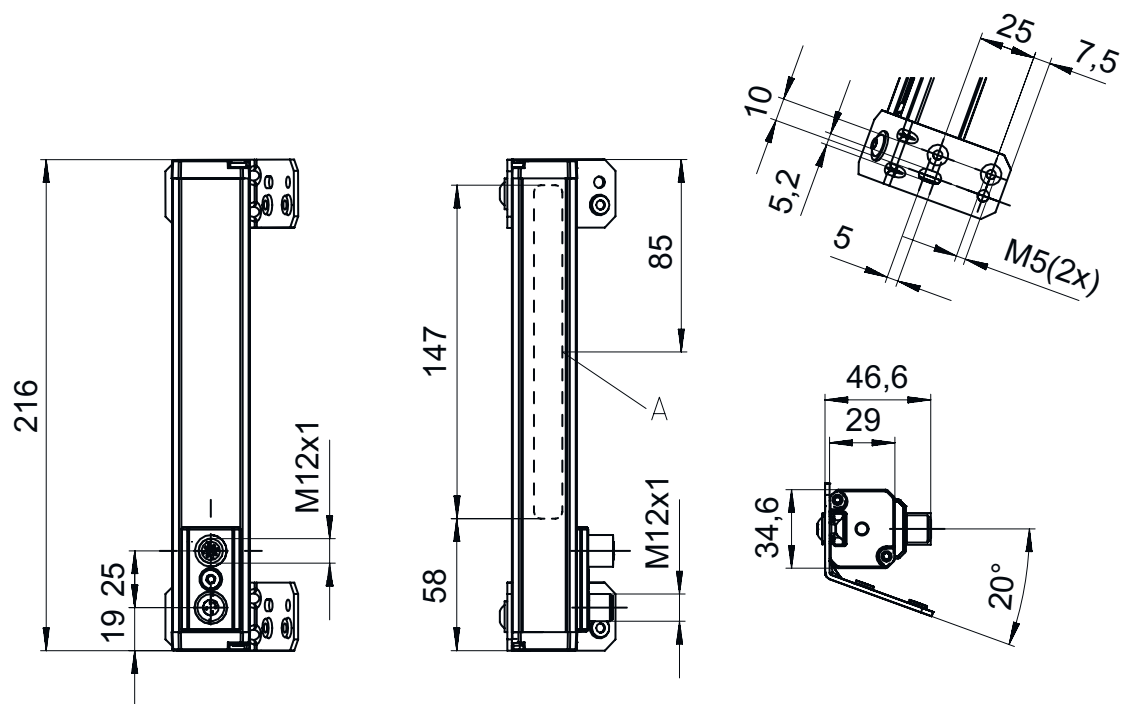

A Integrated illumination

Electrical connection

Connection 1

Function	Data interface
Type of connection	Connector
Thread size	M12
Type	Female
Material	Metal
No. of pins	5 -pin
Encoding	A-coded

Pin	Pin assignment
-----	----------------

1	CAN Shield
2	n.c.
3	CAN GND
4	CAN H
5	CAN L

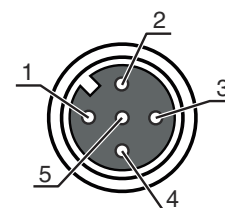

Connection 2

Function	Service interface
	Signal OUT
	Voltage supply
Type of connection	Connector
Thread size	M12
Type	Male
Material	Metal
No. of pins	5 -pin
Encoding	A-coded

Pin	Pin assignment
-----	----------------

1	V+
2	RxD RS232
3	GND
4	OUT 1
5	TxD RS 232

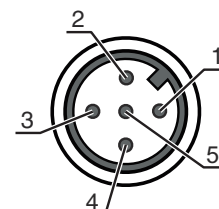

Diagrams

Typical value of characteristic curve: linearity error

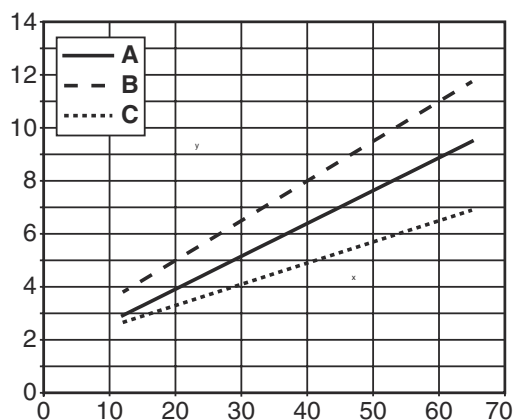

x Floor-sensor distance [mm]

y Linearity error [mm]

A Typical value

B max.

C min.

Diagrams

Sensor characteristic curve with one trace

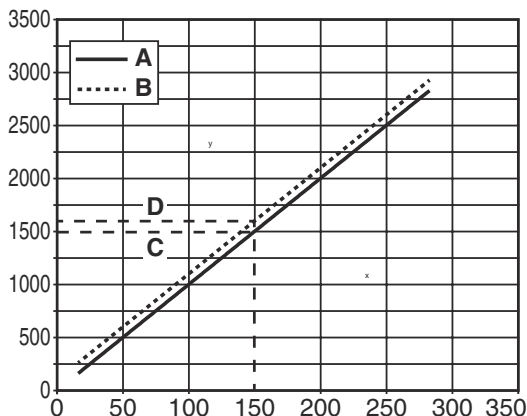

x Position of the trace's left edge below the sensor [mm]
 y Edge position
 A Measurement value of left edge
 B Measurement value of right edge
 C Position of left edge
 D Position of right edge

Notes

⚠ Observe intended use!

- ⚠ This product is not a safety sensor and is not intended as personnel protection.
- ⚠ The product may only be put into operation by competent persons.
- ⚠ Only use the product in accordance with its intended use.

For UL applications:



- ⓘ For UL applications, use is only permitted in Class 2 circuits in accordance with the NEC (National Electric Code).
- ⓘ Max. ambient temperature: 50°C
- ⓘ Only for use in NFPA 79 applications
- ⓘ Only suitable for indoors

Accessories

Connection technology - Connection cables

	Part no.	Designation	Article	Description
	50114693	KB DN/CAN-2000 SA	Connection cable	Application: Oil and lubricant resistant Suitable for interface: DeviceNet, CANopen Connection 1: Connector, M12, Axial, Male, A-coded, 5 -pin Connector, LED: No Connection 2: Open end Shielded: Yes Cable length: 2,000 mm Sheathing material: PUR
	50114697	KB DN/CAN-5000 SA	Connection cable	Application: Oil and lubricant resistant Suitable for interface: CANopen, DeviceNet Connection 1: Connector, M12, Axial, Male, A-coded, 5 -pin Connector, LED: No Connection 2: Open end Shielded: Yes Cable length: 5,000 mm Sheathing material: PUR

Accessories

	Part no.	Designation	Article	Description
	50133839	KD U-M12-5A-P1-020	Connection cable	Application: Oil and lubricant resistant Connection 1: Connector, M12, Axial, Female, A-coded, 5 -pin Connector, LED: No Connection 2: Open end Shielded: No Cable length: 2,000 mm Sheathing material: PUR
	50133841	KD U-M12-5A-P1-050	Connection cable	Application: Oil and lubricant resistant Connection 1: Connector, M12, Axial, Female, A-coded, 5 -pin Connector, LED: No Connection 2: Open end Shielded: No Cable length: 5,000 mm Sheathing material: PUR

Note



A list with all available accessories can be found on the Leuze website in the Download tab of the article detailed page.