

Technical data sheet

Connection cable

Part no.: 548523

CB-D15E-50000S-11GF

Contents

- Technical data
- Electrical connection

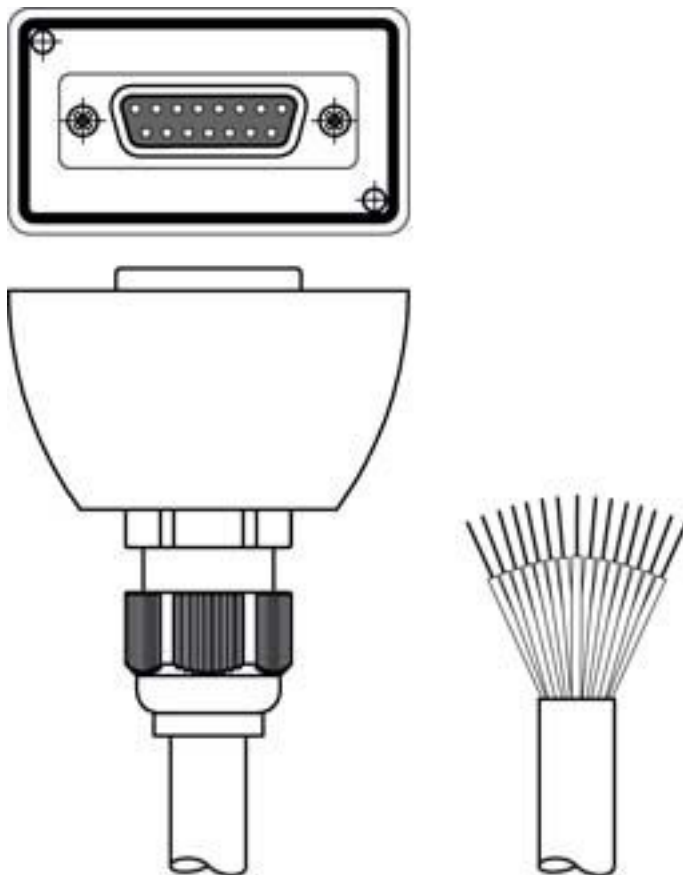

Figure can vary



Technical data

Basic data

Parameter memory	Yes
------------------	-----

Electrical data

Performance data

Operating voltage	30 V AC/DC
-------------------	------------

Connection

Connection 1

Type of connection	Sub-D
Connector, LED	No
Type	Female
No. of pins	15 -pin
Version	Axial

Connection 2

Type of connection	Open end
--------------------	----------

Cable properties

Number of conductors	11 Piece(s)
Sheathing color	Black
Shielded	Yes
Cable design	Connection cable (open on one end)
Cable diameter (external)	8.7 mm
Cable length	50,000 mm
Sheathing material	PUR
Suitability for drag chains	No

Certifications

US patents	US 7,696,468 B
------------	----------------

Classification

Customs tariff number	85444290
ECLASS 5.1.4	27279201
ECLASS 8.0	27279218
ECLASS 9.0	27060311
ECLASS 10.0	27060311
ECLASS 11.0	27060311
ECLASS 12.0	27060311
ECLASS 13.0	27060311
ETIM 5.0	EC001855
ETIM 6.0	EC001855
ETIM 7.0	EC001855
ETIM 8.0	EC001855

Electrical connection

Connection 1

Type of connection	Sub-D
Connector, LED	No
Type	Female
No. of pins	15 -pin
Version	Axial

Connection 2

Type of connection	Open end
--------------------	----------