

Technical data sheet

Transponder

Part no.: 50039069

TFI 05 1601.120

Contents

- Technical data
- Dimensioned drawings
- Notes
- Further information
- Accessories



Figure can vary



Technical data

Basic data

Series	TFI
Suitable for	RFI
Chip	EM4102
Working frequency	0.125 MHz

Electrical data

Performance data

Memory access	Read only
Memory size	8 B
Memory block	1 Piece(s)
Memory block size	1 B
Storage time	100 ms

Certifications

Standards applied	ISO 15693
-------------------	-----------

Mechanical data

Design	Disc
Thickness	2.5 mm
Outer diameter	50 mm
Inner diameter	5 mm
Housing material	Plastic
Net weight	4.5 g
Type of fastening	Through-hole mounting

Environmental data

Ambient temperature, operation	-20 ... 85 °C
Ambient temperature, storage	-20 ... 200 °C

Certifications

Degree of protection	IP 67
----------------------	-------

Classification



Customs tariff number	85235200
ECLASS 5.1.4	27289200
ECLASS 8.0	27289290
ECLASS 9.0	27280402
ECLASS 10.0	27280402
ECLASS 11.0	27280402
ECLASS 12.0	27280402
ECLASS 13.0	27280402
ETIM 5.0	EC002498
ETIM 6.0	EC002996
ETIM 7.0	EC002996
ETIM 8.0	EC002996

Dimensioned drawings

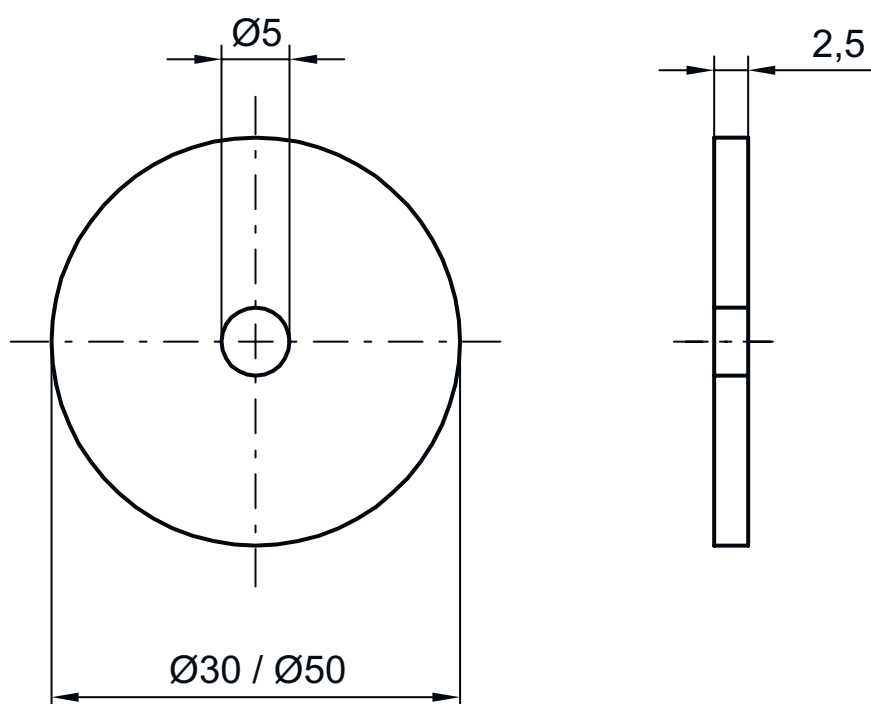
All dimensions in millimeters



Notes

 Observe intended use!	
	<ul style="list-style-type: none"> ⌘ This product is not a safety sensor and is not intended as personnel protection. ⌘ The product may only be put into operation by competent persons. ⌘ Only use the product in accordance with its intended use.

Further information

- Under certain circumstances, metal in the reading field reduces the operating range considerably.

Accessories

Mounting technology - Other

	Part no.	Designation	Article	Description
	50107103	Spacer 50 HT	Spacer	Design, housing: Hollow cylinder Outer diameter: 50 mm Inner diameter: 5 mm Housing material: Plastic, PA 66

Note	
	<ul style="list-style-type: none"> ⌘ A list with all available accessories can be found on the Leuze website in the Download tab of the article detailed page.