

Technical data sheet

Inductive switch

Part no.: 50141481

ISS 218MM/44-8N0-S12

Contents

- Technical data
- Dimensioned drawings
- Electrical connection
- Diagrams
- Operation and display
- Part number code
- Notes
- Accessories



Figure can vary



Technical data

Basic data

Series	218
Typ. operating range limit S_n	8 mm
Operating range S_a	0 ... 6.48 mm

Special version

Special version	Antivalent
-----------------	------------

Characteristic parameters

MTTF	850 years
------	-----------

Electrical data

Protective circuit	Polarity reversal protection
	Short circuit protected
	Transient protection

Performance data

Supply voltage U_B	10 ... 36 V, DC
Residual ripple	0 ... 10 %, From U_B
Open-circuit current	0 ... 16 mA
Temperature drift, max. (in % of S_r)	19 %
Repeatability, max. (in % of S_r)	10 %
Switching hysteresis	20 %

Outputs

Number of digital switching outputs	2 Piece(s)
-------------------------------------	------------

Switching outputs

Voltage type	DC
Switching current, max.	200 mA
Residual current, max.	0.05 mA
Voltage drop	≤ 2 V

Switching output 1

Switching element	Transistor, PNP
Switching principle	NO contact – Antivalent

Switching output 2

Switching element	Transistor, PNP
Switching principle	NC contact – Antivalent

Time behavior

Switching frequency	1,500 Hz
Readiness delay	50 ms

Connection

Number of connections	1 Piece(s)
-----------------------	------------

Connection 1

Function	Signal OUT
	Voltage supply
Type of connection	Connector
Thread size	M12
Type	Male
Material	Metal
No. of pins	4 -pin
Encoding	A-coded

Mechanical data

Design	Cylindrical
Thread size	M18 x 1 mm
Dimension (Ø x L)	18 mm x 64 mm
Type of installation	Non-embedded
Housing material	Metal
Metal housing	Nickel-plated brass
Sensing face material	Plastic, Polybutylene (PBT)
Net weight	32 g
Housing color	Gray
	Silver
Type of fastening	Mounting thread
Standard measuring plate	24 x 24 mm ² , Fe360

Operation and display

Type of display	LED
Number of LEDs	1 Piece(s)

Environmental data

Ambient temperature, operation	-25 ... 70 °C
Ambient temperature, storage	-30 ... 80 °C

Certifications

Degree of protection	IP 67
Protection class	II
Certifications	c UL US
Test procedure for EMC in accordance with standard	EN 61000-4-2, -3, -4, -8

Correction factors

Aluminum	0.5
Stainless steel	0.7
Copper	0.3
Brass	0.5
Fe360 steel	1

Classification

Customs tariff number	85365019
ECLASS 5.1.4	27270101
ECLASS 8.0	27270101
ECLASS 9.0	27270101
ECLASS 10.0	27270101
ECLASS 11.0	27270101
ECLASS 12.0	27274001
ETIM 5.0	EC002714
ETIM 6.0	EC002714
ETIM 7.0	EC002714
ETIM 8.0	EC002714

Dimensioned drawings

All dimensions in millimeters

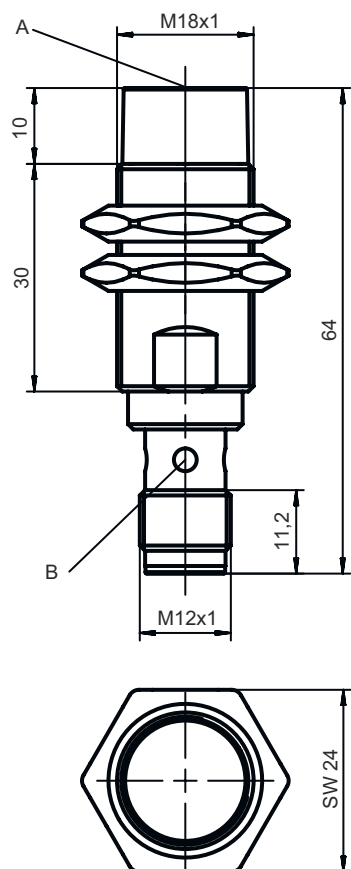

Electrical connection

Connection 1

Function	Signal OUT Voltage supply
Type of connection	Connector
Thread size	M12
Type	Male
Material	Metal
No. of pins	4 -pin
Encoding	A-coded

Pin Pin assignment

1	V+
2	OUT 2
3	GND
4	OUT 1

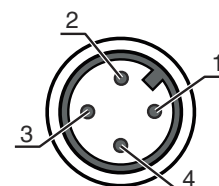

Diagrams

Non-embedded installation

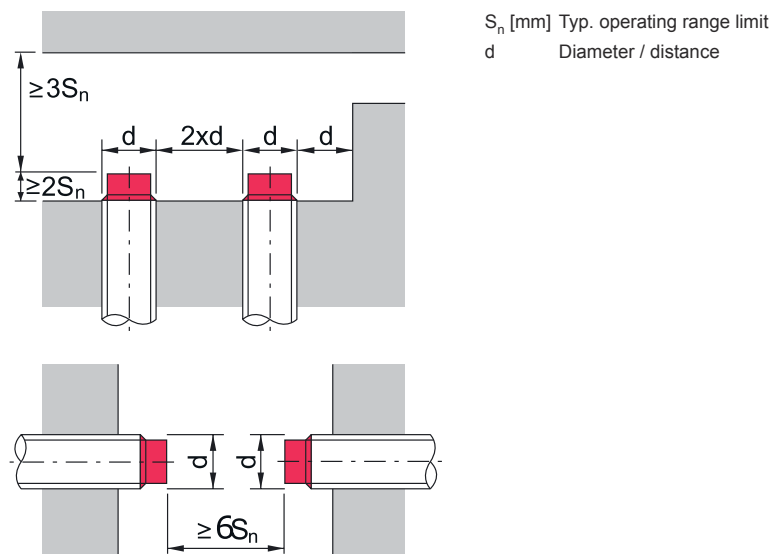

Operation and display

LED	Display	Meaning
1	Yellow, continuous light	Switching output/switching state
	Yellow, flashing	Overload - output

Part number code

Part designation: ISX YYY ZZ/AAA.BB-CCC-DDD-DDD

ISX	Operating principle / construction IS: inductive switch, standard design ISS: inductive switch, short construction
YYY	Series 203: series with \varnothing 3 mm 204: series with \varnothing 4 mm 205: series with M5 x 0.5 external thread 206: series with \varnothing 6.5 mm 208: series with M8 x 1 external thread 212: series with M12 x 1 external thread 218: series with M18 x 1 external thread 230: series with M30 x 1.5 external thread 240: series in cubic design 244: series in cubic design 255: series with 5 x 5 mm ² cross section 288: series with 8 x 8 mm ² cross section
ZZ	Housing / thread MM: metal housing (active surface: plastic) / metric thread FM: Full-metal housing (active surface: stainless steel AISI 316L) / metric thread MP: metal housing (active surface: plastic) / smooth (without thread)
AAA	Output current / supply 4NO: PNP transistor, NO contact 4NC: PNP transistor, NC contact 2NO: NPN transistor, NO contact 2NC: NPN transistor, NC contact 1NO: relay, NO contact / AC/DC 1NC: Relay, NC contact / AC/DC 44: 2 PNP transistor switching outputs, antivalent (NO + NC) 22: 2 NPN transistor switching outputs, antivalent (NO + NC)
BB	Special equipment n/a: no special equipment 5F: Food version 5: housing material V2A (1.4305, AISI 303)

Part number code

CCC	<p>Measurement range / type of installation</p> <p>1E0: typ. range limit 1.0 mm / embedded installation 1E5: typ. range limit 1.5 mm / embedded installation 2E0: typ. range limit 2.0 mm / embedded installation 3E0: typ. range limit 3.0 mm / embedded installation 4E0: typ. range limit 4.0 mm / embedded installation 5E0: typ. range limit 5.0 mm / embedded installation 6E0: typ. range limit 6.0 mm / embedded installation 8E0: typ. range limit 8.0 mm / embedded installation 10E: typ. range limit 10.0 mm / embedded installation 12E: typ. range limit 12.0 mm / embedded installation 15E: typ. range limit 15.0 mm / embedded installation 20E: typ. range limit 20.0 mm / embedded installation 22E: typ. range limit 22.0 mm / embedded installation 2N5: typ. range limit 2.5 mm / non-embedded installation 4N0: typ. range limit 4.0 mm / non-embedded installation 8N0: typ. range limit 8.0 mm / non-embedded installation 10N: typ. range limit 10.0 mm / non-embedded installation 12N: typ. range limit 12.0 mm / non-embedded installation 14N: typ. range limit 14.0 mm / non-embedded installation 15N: typ. range limit 15.0 mm / non-embedded installation 20N: typ. range limit 20.0 mm / non-embedded installation 22N: typ. range limit 22.0 mm / non-embedded installation 25N: typ. range limit 25.0 mm / non-embedded installation 40N: typ. range limit 40.0 mm / non-embedded installation</p>
DDD	<p>Electrical connection</p> <p>n/a: cable, standard length 2000 mm S12: M12 connector, 4-pin, axial 200-S12: cable, length 200 mm with M12 connector, 4-pin, axial 200-S8.3: cable, length 200 mm with M8 connector, 3-pin, axial S8.3: M8 connector, 3-pin, axial 005-S8.3: cable, length 500 mm with M8 connector, 3-pin, axial 050: cable, standard length 5000 mm, 3-wire</p>





Notes

Observe intended use!	
	<ul style="list-style-type: none"> ⚠ This product is not a safety sensor and is not intended as personnel protection. ⚠ The product may only be put into operation by competent persons. ⚠ Only use the product in accordance with its intended use.

For UL applications:	
	<ul style="list-style-type: none"> ⚠ For UL applications, use is only permitted in Class 2 circuits in accordance with the NEC (National Electric Code).

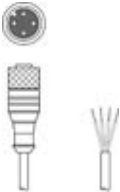
Accessories

Connection technology - Connection cables

	Part no.	Designation	Article	Description
	50130654	KD U-M12-4A-P1-020	Connection cable	Connection 1: Connector, M12, Axial, Female, A-coded, 4 -pin Connector, LED: No Connection 2: Open end Shielded: No Cable length: 2.000 mm Sheathing material: PUR
	50130657	KD U-M12-4A-P1-050	Connection cable	Connection 1: Connector, M12, Axial, Female, A-coded, 4 -pin Connector, LED: No Connection 2: Open end Shielded: No Cable length: 5.000 mm Sheathing material: PUR
	50130648	KD U-M12-4A-V1-020	Connection cable	Connection 1: Connector, M12, Axial, Female, A-coded, 4 -pin Connector, LED: No Connection 2: Open end Shielded: No Cable length: 2.000 mm Sheathing material: PVC
	50130652	KD U-M12-4A-V1-050	Connection cable	Connection 1: Connector, M12, Axial, Female, A-coded, 4 -pin Connector, LED: No Connection 2: Open end Shielded: No Cable length: 5.000 mm Sheathing material: PVC

Mounting technology - Mounting brackets



	Part no.	Designation	Article	Description
	50113548	BT D18M.5	Mounting bracket	Diameter, inner: 18 mm Design of mounting device: Angle, L-shape Fastening, at system: Through-hole mounting Mounting bracket, at device: Screw type Type of mounting device: Rigid Material: Stainless steel

Mounting technology - Rod mounts

	Part no.	Designation	Article	Description
	50117490	BTU D18M-D12	Mounting system	Design of mounting device: Mounting system Fastening, at system: Through-hole mounting Mounting bracket, at device: Screw type Type of mounting device: Clampable, Adjustable, Turning, 360° Material: Metal

Accessories

Mounting technology - Other

	Part no.	Designation	Article	Description
	50111501	MC 018K	Clamp	Diameter, inner: 18 mm Design of mounting device: Mounting clamp Fastening, at system: Through-hole mounting Mounting bracket, at device: Clampable Type of mounting device: Rigid Material: Plastic
	50111502	MC 018K-LS	Clamp	Diameter, inner: 18 mm Design of mounting device: Mounting clamp Fastening, at system: Through-hole mounting Mounting bracket, at device: Clampable with limit stop Type of mounting device: Rigid Material: Plastic

Note



A list with all available accessories can be found on the Leuze website in the Download tab of the article detailed page.