

Technical data sheet

Dynamic reference diffuse sensor

Part no.: 50146837

DRT25C.3/4P-M12



Figure can vary

Contents

- Technical data
- Dimensioned drawings
- Electrical connection
- Operation and display
- Part number code
- Notes
- Further information
- Accessories



Technical data

Basic data

| | |
|---------------------|-------------------------------|
| Series | 25C |
| Operating principle | Reference teach on background |

Optical data

| | |
|--------------------------|--------------------------------------|
| Operating range | Max. distance to reference surface |
| Operating range | 0.05 ... 0.2 m |
| Adjustment range | 50 ... 200 mm |
| Light source | LED, Red |
| Wavelength | 645 nm |
| Transmitted-signal shape | Pulsed |
| LED group | Exempt group (in acc. with EN 62471) |

Electrical data

| | |
|--------------------|---|
| Protective circuit | Polarity reversal protection Short circuit protected |
|--------------------|---|

Performance data

| | |
|----------------------|--|
| Supply voltage U_B | 12 ... 30 V, DC, Incl. residual ripple |
| Residual ripple | 0 ... 15 %, From U_B |
| Open-circuit current | 0 ... 40 mA |

Outputs

| | |
|-------------------------------------|------------|
| Number of digital switching outputs | 2 Piece(s) |
|-------------------------------------|------------|

Switching outputs

| | |
|-------------------------|---|
| Voltage type | DC |
| Switching current, max. | 100 mA |
| Switching voltage | high: $\geq(U_B - 2.5V)$ low: $\leq 2.5 V$ |

Switching output 1

| | |
|---------------------|---------------------|
| Assignment | Connection 1, pin 4 |
| Switching element | Transistor, PNP |
| Switching principle | Light switching |

Switching output 2

| | |
|---------------------|---------------------|
| Assignment | Connection 1, pin 2 |
| Switching element | Transistor, PNP |
| Switching principle | Dark switching |

Time behavior

| | |
|---------------------|---------------------------------|
| Switching frequency | 750 Hz, (Teach level 1: 500 Hz) |
| Response time | 0.66 ms |
| Readiness delay | 300 ms |

Connection

Connection 1

| | |
|--------------------|------------------------------|
| Function | Signal OUT Voltage supply |
| Type of connection | Connector |
| Thread size | M12 |
| Type | Male |
| Material | PUR |
| No. of pins | 4 -pin |
| Encoding | A-coded |

Mechanical data

| | |
|----------------------------|--|
| Dimension (W x H x L) | 15 mm x 42.7 mm x 30 mm |
| Housing material | Plastic |
| Plastic housing | ABS |
| Lens cover material | Plastic |
| Net weight | 22 g |
| Housing color | Red |
| Type of fastening | Through-hole mounting with M4 thread Via optional mounting device |
| Compatibility of materials | ECOLAB |

Operation and display

| | |
|-------------------------------------|-------------------------------|
| Type of display | LED |
| Number of LEDs | 2 Piece(s) |
| Operational controls | Teach button |
| Function of the operational control | Teach-in on reference surface |

Environmental data

| | |
|--------------------------------|--|
| Ambient temperature, operation | -10 ... 50 °C, Temperature compensation $\pm 15^\circ\text{C}$ |
| Ambient temperature, storage | -40 ... 70 °C |

Certifications

| | |
|----------------------|-----------------|
| Degree of protection | IP 67 IP 69K |
| Protection class | III |
| Certifications | c UL US |
| Standards applied | IEC 60947-5-2 |

Classification

| | |
|-----------------------|----------|
| Customs tariff number | 85365019 |
| ECLASS 5.1.4 | 27270903 |
| ECLASS 8.0 | 27270903 |
| ECLASS 9.0 | 27270903 |
| ECLASS 10.0 | 27270903 |
| ECLASS 11.0 | 27270903 |
| ECLASS 12.0 | 27270903 |
| ETIM 5.0 | EC001821 |
| ETIM 6.0 | EC001821 |
| ETIM 7.0 | EC001821 |
| ETIM 8.0 | EC001821 |

Dimensioned drawings

All dimensions in millimeters

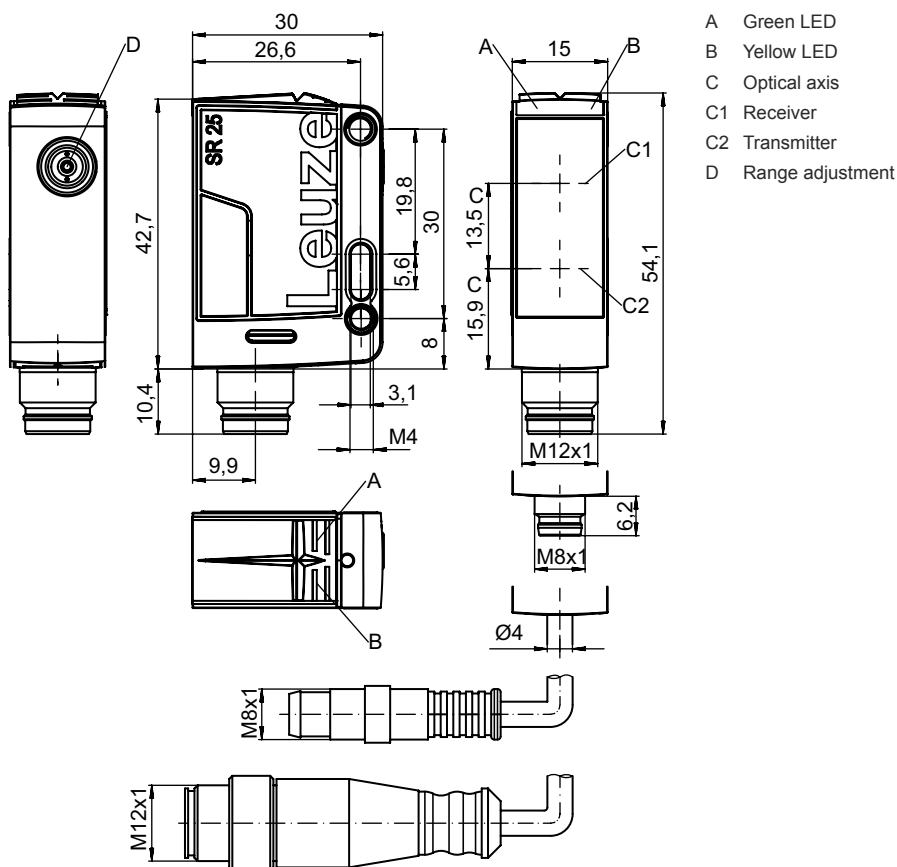

Electrical connection

Connection 1

| | |
|--------------------|----------------|
| Function | Signal OUT |
| | Voltage supply |
| Type of connection | Connector |
| Thread size | M12 |
| Type | Male |
| Material | PUR |
| No. of pins | 4 -pin |
| Encoding | A-coded |

| Pin | Pin assignment |
|-----|----------------|
| 1 | V+ |
| 2 | OUT 2 |
| 3 | GND |
| 4 | OUT 1 |

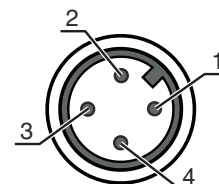

Operation and display

| LED | Display | Meaning |
|-----|-------------------------|-----------------------|
| 1 | Green, continuous light | Operational readiness |

Operation and display

| LED | Display | Meaning |
|-----|--------------------------|-----------------|
| 2 | Yellow, continuous light | Object detected |

Part number code

Part designation: **AAA25C d EE-f.GGH/IJ-K**

| | |
|---------------|---|
| AAA25C | Operating principle / construction HT25C: Diffuse reflection sensor with background suppression PRK25C: Retro-reflective photoelectric sensor with polarization filter LS25C: Throughbeam photoelectric sensor transmitter LE25C: Throughbeam photoelectric sensor receiver DRT25C: Dynamic reference diffuse sensor |
| d | Light type n/a: red light l: infrared light |
| EE | Light source n/a: LED L1: laser class 1 L2: laser class 2 |
| f | Preset range (optional) n/a: operating range acc. to data sheet xxxF: Preset range [mm] |
| GG | Equipment A: Autocollimation principle (single lens) S: small light spot D: Detection of stretch-wrapped objects X: extended model HF: Suppression of HF illumination (LED) XL: Extra long light spot T: autocollimation principle (single lens) for highly transparent bottles without tracking TT: autocollimation principle (single lens) for highly transparent bottles with tracking F: Foreground suppression R: greater operating range SL: Slit diaphragm |
| H | Operating range adjustment 1: 270° potentiometer 2: multiturn potentiometer 3: teach-in via button R: greater operating range |
| i | Switching output/function OUT 1/IN: Pin 4 or black conductor 2: NPN transistor output, light switching N: NPN transistor output, dark switching 4: PNP transistor output, light switching P: PNP transistor output, dark switching X: pin not used 8: activation input (activation with high signal) L: IO-Link interface (SIO mode: PNP light switching, NPN dark switching) 6: push-pull switching output, PNP light switching, NPN dark switching G: Push-pull switching output, PNP dark switching, NPN light switching |
| J | Switching output / function OUT 2/IN: pin 2 or white conductor 2: NPN transistor output, light switching N: NPN transistor output, dark switching 4: PNP transistor output, light switching P: PNP transistor output, dark switching W: warning output X: pin not used 6: push-pull switching output, PNP light switching, NPN dark switching T: teach-in via cable G: Push-pull switching output, PNP dark switching, NPN light switching 8: activation input (activation with high signal) |

Part number code

| | |
|----------|--|
| K | <p>Electrical connection n/a: cable, standard length 2000 mm, 4-wire 200-M12: cable, length 200 mm with M12 connector, 4-pin, axial (plug) M8: M8 connector, 4-pin (plug) M12: M12 connector, 4-pin (plug) 200-M8: cable, length 200 mm with M8 connector, 4-pin, axial (plug)</p> |
|----------|--|

Note

| | |
|--|--|
| | <p>A list with all available device types can be found on the Leuze website at www.leuze.com.</p> |
|--|--|

Notes

Observe intended use!

| | |
|--|---|
| | <ul style="list-style-type: none"> ⌘ This product is not a safety sensor and is not intended as personnel protection. ⌘ The product may only be put into operation by competent persons. ⌘ Only use the product in accordance with its intended use. |
|--|---|

Further information

- Light source: Average life expectancy 100,000 h at an ambient temperature of 25 °C

Accessories

Connection technology - Connection cables





| | Part no. | Designation | Article | Description |
|--|----------|--------------------|------------------|--|
| | 50130652 | KD U-M12-4A-V1-050 | Connection cable | Connection 1: Connector, M12, Axial, Female, A-coded, 4 -pin Connector, LED: No Connection 2: Open end Shielded: No Cable length: 5.000 mm Sheathing material: PVC |
| | 50130690 | KD U-M12-4W-V1-050 | Connection cable | Connection 1: Connector, M12, Angled, Female, A-coded, 4 -pin Connector, LED: No Connection 2: Open end Shielded: No Cable length: 5.000 mm Sheathing material: PVC |

Accessories

Mounting technology - Mounting brackets

| | Part no. | Designation | Article | Description |
|---|----------|-------------|------------------|---|
|  | 50118543 | BT 300M.5 | Mounting bracket | Design of mounting device: Angle, L-shape Fastening, at system: Through-hole mounting Mounting bracket, at device: Screw type, Suited for M4 screws Type of mounting device: Adjustable Material: Stainless steel |

Mounting technology - Rod mounts

| | Part no. | Designation | Article | Description |
|---|----------|-----------------|-----------------|--|
|  | 50117829 | BTP 200M-D12 | Mounting system | Design of mounting device: Protection hood Fastening, at system: For 12 mm rod Mounting bracket, at device: Screw type Type of mounting device: Clampable, Adjustable, Turning, 360° Material: Metal |
|  | 50117252 | BTU 300M-D12 | Mounting system | Design of mounting device: Mounting system Fastening, at system: For 12 mm rod, Sheet-metal mounting Mounting bracket, at device: Screw type, Suited for M4 screws Type of mounting device: Clampable, Adjustable, Turning, 360° Material: Metal |
|  | 50142207 | BTU 300M-D12-90 | Rod mounting | Design of mounting device: Mounting system Fastening, at system: For 12 mm rod, Sheet-metal mounting Mounting bracket, at device: Screw type, Suited for M4 screws Type of mounting device: Clampable, Adjustable, Turning, 360° Material: Metal |
|  | 50142208 | BTU D12M-L-200 | Rod | Design of mounting device: Rod Fastening, at system: Clampable Mounting bracket, at device: Clampable Material: Metal |

Note



A list with all available accessories can be found on the Leuze website in the Download tab of the article detailed page.