

## Technical data sheet Stationary bar code reader

Part no.: 50143213

BCL 258i SM 110



For illustration purposes only

### Contents

- Technical data
- Dimensioned drawings
- Electrical connection
- Diagrams
- Operation and display
- Part number code
- Notes
- Accessories



EtherNet/IP<sup>®</sup>  
certification mark



UK  
CA

## Technical data

### Basic data

Series	BCL 200i
--------	----------

### Functions

Functions	Alignment mode
	AutoConfig
	AutoControl
	AutoRefAct
	Code fragment technology
	LED indicator
	Reference code comparison

### Read data

Code types, readable	2/5 Interleaved
	Codabar
	Code 128
	Code 39
	Code 93
	EAN 8/13
	GS1 Databar Expanded
	GS1 Databar Limited
	GS1 Databar Omnidirectional
	UPC
Scanning rate, typical	1,000 scans/s
Bar codes per reading gate, max. number	64 Piece(s)

### Optical data

Reading distance	40 ... 255 mm
Light source	Laser, Red
Wavelength	655 nm
Laser class	1, IEC/EN 60825-1:2014
Transmitted-signal shape	Continuous
Usable opening angle (reading field opening)	60 °
Modulus size	0.2 ... 0.5 mm
Reading method	Line scanner with deflecting mirror
Beam deflection	By means of rotating polygon mirror wheel + deflecting mirror
Light beam exit	Lateral with deflecting mirror

### Electrical data

Protective circuit	Polarity reversal protection
--------------------	------------------------------

#### Performance data

Supply voltage $U_B$	18 ... 30 V, DC
Power consumption, max.	4 W

#### Inputs

Number of digital switching inputs	1 Piece(s)
------------------------------------	------------

#### Switching inputs

Voltage type	DC
Input current, max.	8 mA

#### Outputs

Number of digital switching outputs	1 Piece(s)
-------------------------------------	------------

#### Switching outputs

Voltage type	DC
Switching current, max.	60 mA

### Interface

Type	EtherNet IP
------	-------------

#### EtherNet IP

Function	Process
Address assignment	DHCP
Switch functionality	None
Transmission speed	10 Mbit/s
	100 Mbit/s

### Connection

Number of connections	2 Piece(s)
-----------------------	------------

#### Connection 1

Function	Signal IN
	Signal OUT
	Voltage supply
Type of connection	Cable with connector
Cable length	900 mm
Sheathing material	PVC
Cable color	Black
Number of conductors	5 -wire
Thread size	M12
Type	Male
Material	Plastic
No. of pins	5 -pin
Encoding	A-coded

#### Connection 2

Function	Configuration interface
	Data interface
Type of connection	Cable with connector
Cable length	700 mm
Sheathing material	PVC
Cable color	Green
Number of conductors	4 -wire
Thread size	M12
Type	Female
Material	Plastic
No. of pins	4 -pin
Encoding	D-coded

### Mechanical data

Design	Cubic
Dimension (W x H x L)	93 mm x 38 mm x 83 mm
Housing material	Metal
Metal housing	Diecast aluminum
Lens cover material	Glass
Net weight	400 g
Housing color	Silver
Type of fastening	Dovetail grooves
	Fastening on back
	Via optional mounting device

### Operation and display

Type of display	LED
Number of LEDs	3 Piece(s)
Type of configuration	Via web browser

## Technical data

### Environmental data

Ambient temperature, operation	0 ... 40 °C
Ambient temperature, storage	-20 ... 70 °C
Relative humidity (non-condensing)	0 ... 90 %

### Certifications

Degree of protection	IP 65
Protection class	III
Approvals	c UL US
Test procedure for EMC in accordance with standard	EN 61000-6-2 EN 61000-6-3
Test procedure for shock in accordance with standard	IEC 60068-2-27, test Ea
Test procedure for continuous shock in accordance with standard	IEC 60068-2-29, test Eb
Test procedure for vibration in accordance with standard	IEC 60068-2-6, test Fc

### Classification

Customs tariff number	84719000
ECLASS 5.1.4	27280102
ECLASS 8.0	27280102
ECLASS 9.0	27280102
ECLASS 10.0	27280102
ECLASS 11.0	27280102
ECLASS 12.0	27280102
ECLASS 13.0	27280102
ECLASS 14.0	27280102
ECLASS 15.0	27280102
ECLASS 16.0	27280102
ETIM 5.0	EC002550
ETIM 6.0	EC002550
ETIM 7.0	EC002550
ETIM 8.0	EC002550
ETIM 9.0	EC002550
ETIM 10.0	EC002550
UNSPSC 26.08	43211701

# Dimensioned drawings

All dimensions in millimeters

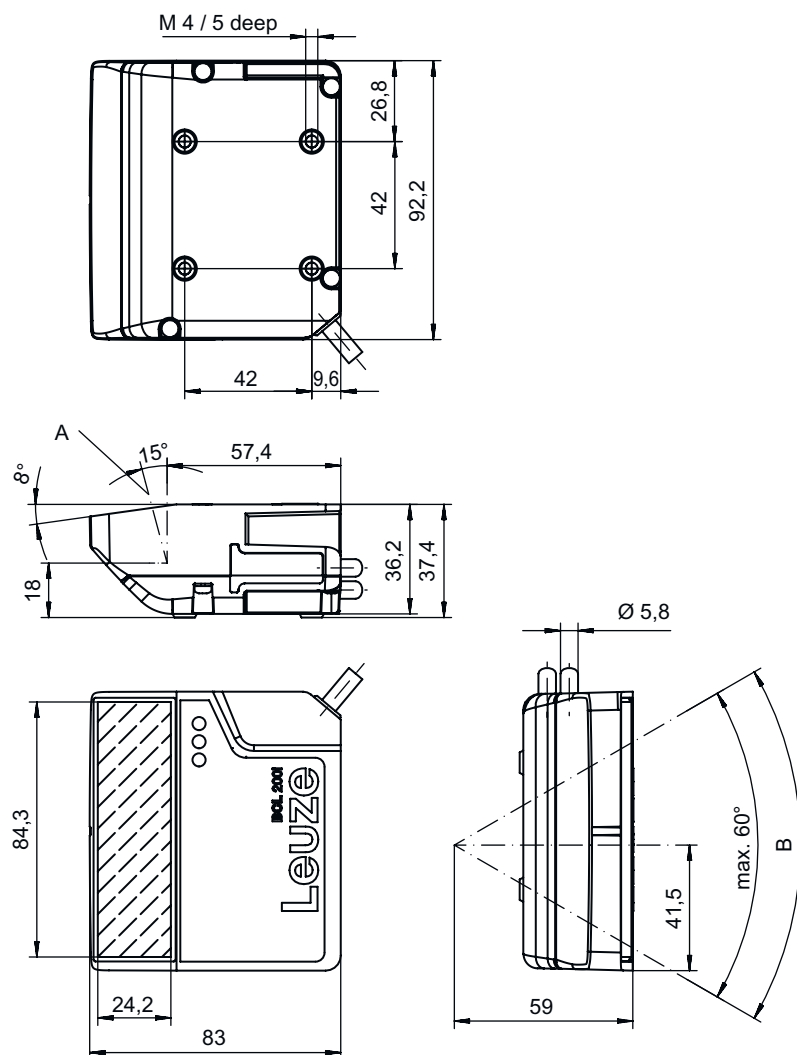

- A Optical axis
- B Deflection angle of the laser beam:  $\pm 30^\circ$

## Electrical connection

### Connection 1

Function	Signal IN
	Signal OUT
	Voltage supply
Type of connection	Cable with connector
Cable length	900 mm
Sheathing material	PVC
Cable color	Black
Number of conductors	5 -wire
Thread size	M12
Type	Male
Material	Plastic
No. of pins	5 -pin
Encoding	A-coded

## Electrical connection

### Pin Pin assignment

1	VIN
2	SWIN 1
3	GNDIN
4	SWO 1
5	FE



### Connection 2

<b>Function</b>	Configuration interface Data interface
<b>Type of connection</b>	Cable with connector
<b>Cable length</b>	700 mm
<b>Sheathing material</b>	PVC
<b>Cable color</b>	Green
<b>Number of conductors</b>	4 -wire
<b>Thread size</b>	M12
<b>Type</b>	Female
<b>Material</b>	Plastic
<b>No. of pins</b>	4 -pin
<b>Encoding</b>	D-coded

### Pin Pin assignment

1	TD0+
2	RD0+
3	TD0-
4	RD0-



# Diagrams

## Reading field curve

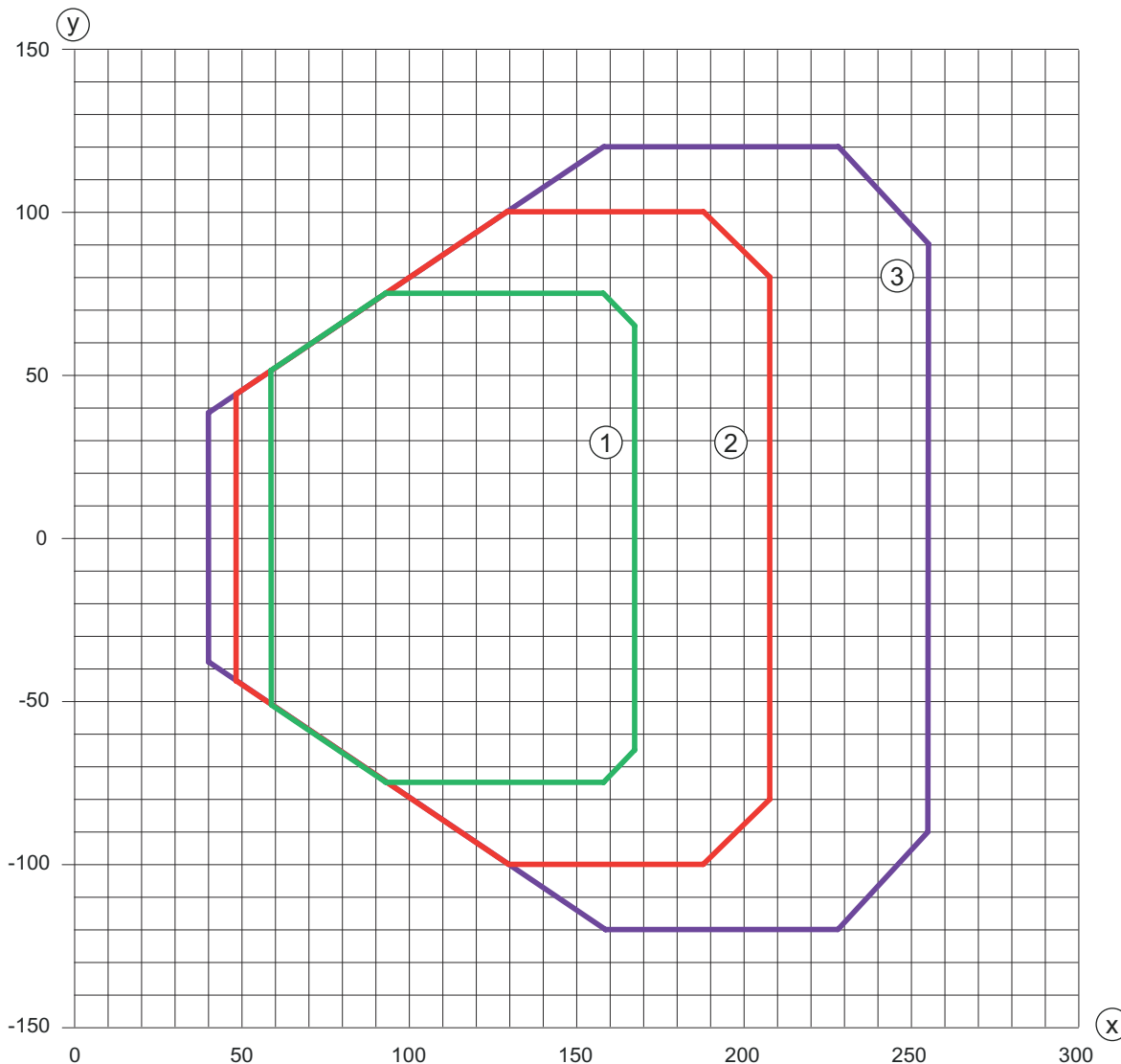

x Reading distance [mm]  
 y Reading field width [mm]

- 1 Module: 0.2 mm
- 2 Module: 0.3 mm
- 3 Module: 0.5 mm

## Operation and display

LED	Display	Meaning
1 PWR	Green, flashing	Device ok, initialization phase
	Green, continuous light	Device OK
	Green, briefly off - on	Reading successful
	Green, briefly off - briefly red - on	Reading not successful
	Orange, continuous light	Service mode
	Red, flashing	Device OK, warning set
	Red, continuous light	Error, device error
	2 NET	Green, flashing
	Green, continuous light	Bus operation ok

# Operation and display

LED	Display	Meaning
2 NET	Red, flashing	Communication error
	Red, continuous light	Bus error
3 LINK	Green, continuous light	Ethernet connection is established
	Yellow, continuous light	Data exchange active

## Part number code

Part designation: **BCL XXXX YYZ AAA**

<b>BCL</b>	<b>Operating principle</b> BCL: bar code reader
<b>XXXX</b>	<b>Series/interface (integrated fieldbus technology)</b> 208i: EtherNet TCP/IP, UDP 248i: PROFINET RT 258i: EtherNet/IP
<b>YY</b>	<b>Scanning principle</b> S: line scanner (single line) R1: line scanner (raster)
<b>Z</b>	<b>Optics</b> M: Medium Density (medium distance)
<b>AAA</b>	<b>Beam exit</b> 110: lateral

**Note**



A list with all available device types can be found on the Leuze website at [www.leuze.com](http://www.leuze.com).

## Notes

**! Observe intended use!**



- This product is not a safety sensor and is not intended as personnel protection.
- The product may only be put into operation by competent persons.
- Only use the product in accordance with its intended use.

**! ATTENTION! LASER RADIATION – CLASS 1 LASER PRODUCT**



The device satisfies the requirements of IEC/EN 60825-1:2014 safety regulations for a product of **laser class 1** and complies with 21 CFR 1040.10 except for conformance with IEC 60825-1 Ed. 3., as described in Laser Notice No. 56, dated May 8, 2019.

- Observe the applicable statutory and local laser protection regulations.
- The device must not be tampered with and must not be changed in any way. There are no user-serviceable parts inside the device. Repairs must only be performed by Leuze electronic GmbH + Co. KG.



**! Laser radiation**



- Opening the device may result in hazardous radiation exposure.

## Accessories

### Connection technology - Connection cables

	Part no.	Designation	Article	Description
	50132079	KD U-M12-5A-V1-050	Connection cable	Application: Chemical resistant Connection 1: Connector, M12, Axial, Female, A-coded, 5 -pin Connector, LED: No Connection 2: Open end Shielded: No Cable length: 5,000 mm Sheathing material: PVC
	50135074	KS ET-M12-4A-P7-050	Connection cable	Application: Oil and lubricant resistant Suitable for interface: Ethernet Connection 1: Connector, M12, Axial, Male, D-coded, 4 -pin Connector, LED: No Connection 2: Open end Shielded: Yes Cable length: 5,000 mm Sheathing material: PUR

### Connection technology - Interconnection cables

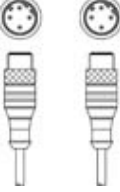
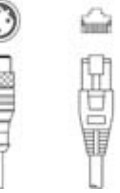
	Part no.	Designation	Article	Description
	50137078	KSS ET-M12-4A-M12-4A-P7-050	Interconnection cable	Application: Oil and lubricant resistant Suitable for interface: Ethernet Connection 1: Connector, M12, Axial, Male, D-coded, 4 -pin Connection 2: Connector, M12, Axial, Male, D-coded, 4 -pin Shielded: Yes Cable length: 5,000 mm Sheathing material: PUR
	50135081	KSS ET-M12-4A-RJ45-A-P7-050	Interconnection cable	Application: Oil and lubricant resistant Suitable for interface: Ethernet Connection 1: Connector, M12, Axial, Male, D-coded, 4 -pin Connection 2: RJ45 Shielded: Yes Cable length: 5,000 mm Sheathing material: PUR

### Mounting technology - Mounting brackets

	Part no.	Designation	Article	Description
	50121433	BT 300 W	Mounting device	Contains: 4x M4 x 10 screw, 2x M6 x 10 screws, 4x M3 x 8 screw Design of mounting device: Angle, L-shape Fastening, at system: Through-hole mounting Mounting bracket, at device: Screw type Type of mounting device: Adjustable Material: Metal





### Mounting technology - Rod mounts

	Part no.	Designation	Article	Description
	50121434	BT 300 - 1	Mounting device	Contains: 4x M4 x 10 screw, 2x M6 x 10 screws, 4x M3 x 8 screw Design of mounting device: Mounting system Fastening, at system: For 10-16 mm rods Mounting bracket, at device: Screw type Type of mounting device: Turning, 360°, Adjustable Material: Metal

## Accessories

	Part no.	Designation	Article	Description
	50121435	BT 56 - 1	Mounting device	Functions: Static applications Design of mounting device: Mounting system Fastening, at system: For 12 mm rod, For 14 mm rod, For 16 mm rod Mounting bracket, at device: Clampable Material: Metal Tightening torque of the clamping jaws: 8 N·m

## Services

	Part no.	Designation	Article	Description
	S981020	CS30-E-212	Hourly rate	Details: Compilation of the application data, selection and suggestion of suitable sensor system, drawing prepared as assembly sketch. Conditions: Completed questionnaire or project specifications with a description of the application have been provided.
	S981014	CS30-S-110	Start-up support	Details: Performed at location of customer's choosing, duration: max. 10 hours. Conditions: Devices and connection cables are already mounted, price not including travel costs and, if applicable, accommodation expenses.
	S981019	CS30-T-110	Product training	Details: Location and content to be agreed upon, duration: max. 10 hours. Conditions: Price not including travel costs and, if applicable, accommodation expenses.
	S981021	CS30-V-212	Hourly rate	Details: REA evaluation with creation of a test report, evaluation of the code quality. Conditions: Original bar codes to be provided by the client.

### Note



A list with all available accessories can be found on the Leuze website in the Download tab of the article detailed page.