

Technical data sheet Contour measurement system

Part no.: 50143584

CMS708i-ENC1-0640-0960



Contents

- Set consists of
- Technical data
- Dimensioned drawings
- Electrical connection
- Diagrams
- Notes
- Accessories



Set consists of

	Quantity	Part no.	Designation	Article	Description
	2	424417	BT-2P40	Mounting bracket set	Contains: BT-P40 clamp bracket, 2x Bore hole 1: M6 Bore hole 2: M6 Design of mounting device: Mounting clamp Fastening, at system: Groove mounting Mounting bracket, at device: Groove mounting Type of mounting device: Clampable, Suitable for mounting in UDC-S2, DC-S2 device columns Material: Metal
	1	50118744	CML730i-R05-640.A/L-M12	Light curtain receiver	Interface: IO-Link Connection: Connector, M12, Axial, 8 -pin
	1	50118748	CML730i-R05-960.A/L-M12	Light curtain receiver	Interface: IO-Link Connection: Connector, M12, Axial, 8 -pin
	1	50118583	CML730i-T05-640.A-M12	Light curtain transmitter	Operating range: 0.1 ... 4 m Connection: Connector, M12, Axial, 5 -pin
	1	50118587	CML730i-T05-960.A-M12	Light curtain transmitter	Operating range: 0.1 ... 4 m Connection: Connector, M12, Axial, 5 -pin
	2	50129781	KDS DN-M12-5A-M12-5A-P3-050	Interconnection cable	Application: Oil and lubricant resistant Suitable for interface: DeviceNet, CANopen Connection 1: Connector, M12, Axial, Female, A-coded, 5 -pin Connection 2: Connector, M12, Axial, Male, A-coded, 5 -pin Shielded: Yes Cable length: 5,000 mm Sheathing material: PUR
	3	50135146	KDS S-M12-8A-M12-8A-P1-050	Interconnection cable	Application: Oil and lubricant resistant Connection 1: Connector, M12, Axial, Female, A-coded, 8 -pin Connection 2: Connector, M12, Axial, Male, A-coded, 8 -pin Shielded: Yes Cable length: 5,000 mm Sheathing material: PUR
	1	50144568	LMSMA35500024KH 10M16	Rotary encoder	

Set consists of

	Quantity	Part no.	Designation	Article	Description
	1	50142930	LSC708-ENC-100	Switch cabinet	Supply voltage: 100 ... 263 V, AC Switching inputs: 4 Piece(s) Switching outputs: 4 Piece(s) Connections: 11 Piece(s)

Technical data

Basic data

Series	CMS 7xxi
Contains	1x dongle CMS700 1x rotary encoder
Order guide	Additional models on request

Functions

Functions	For a minimum object height ≥ 5 mm
-----------	---

Optical data

Operating range	0.1 ... 4.5 m
Operating range, transparent media	0.1 ... 1.75 m
Operating range limit	0.1 ... 6 m
Measurement field length 1	640 mm
Measurement field length 2	960 mm
Beam spacing	5 mm

Electrical data

Protective circuit	Polarity reversal protection Short circuit protected Transient protection
Output current, continuous current per channel, max.	100 mA

Performance data

Supply voltage U_B	100 ... 263 V
Open-circuit current	250 mA

Inputs

Number of digital switching inputs	4 Piece(s)
------------------------------------	------------

Switching inputs

Type	Digital switching input
Voltage type	DC
Switching voltage	24 V, VIN

Outputs

Number of digital switching outputs	4 Piece(s)
-------------------------------------	------------

Switching outputs

Type	Digital switching output
Voltage type	AC
Switching voltage	24 V, VIN

Interface

Type	EtherNet TCP/IP
------	-----------------

Ethernet

Function	Configuration / process data
----------	------------------------------

Connection

Number of connections	11 Piece(s)
-----------------------	-------------

Connection 1

Function	Earthing
Type of connection	Screw fitting
Material	Metal

Connection 2

Function	Voltage supply
Type of connection	Mains plug
Material	Metal

Connection 3

Function	Width measuring light curtain connection
Type of connection	Connector
Thread size	M12
Type	Female
Material	Metal
No. of pins	4 -pin
Encoding	D-coded

Connection 4

Function	Height measuring light curtain connection
Type of connection	Connector
Thread size	M12
Type	Female
Material	Metal
No. of pins	8 -pin
Encoding	A-coded

Connection 5

Function	Rotary encoder connection (not in combination with length measuring light curtain)
Type of connection	Connector
Thread size	M12
Type	Female
Material	Metal
No. of pins	8 -pin
Encoding	A-coded

Connection 6

Function	External Ethernet TCP/IP connection
Type of connection	Connector
Thread size	M12
Type	Female
Material	Metal
No. of pins	4 -pin
Encoding	A-coded

Technical data

Connection 7

Function	PROFINET IN connection (optional)
Type of connection	Connector
Thread size	M12
Type	Female
Material	Metal
No. of pins	4 -pin
Encoding	A-coded

Connection 8

Type of connection	Connector
Thread size	M12
Type	Female
Material	Metal
No. of pins	4 -pin
Encoding	A-coded

Connection 9

Type of connection	Connector
Thread size	M12
Type	Female
Material	Metal
No. of pins	4 -pin
Encoding	A-coded

Mechanical data

Design	Cubic
Housing material	Metal
Metal housing	Aluminum
Lens cover material	Plastic
Net weight	12,750 g
Housing color	Gray
	Red

Note Dimensions of individual set items, see dimensioned drawings

Operation and display

Type of display	LED
Number of LEDs	3 Piece(s)
Type of configuration	performed via webConfig
Operational controls	Rotary switch

Environmental data

Ambient temperature, operation	0 ... 45 °C
Ambient temperature, storage	-20 ... 70 °C

Classification

Customs tariff number	90314990
ECLASS 5.1.4	27270910
ECLASS 8.0	27270910
ECLASS 9.0	27270910
ECLASS 10.0	27270910
ECLASS 11.0	27270910
ECLASS 12.0	27270910
ECLASS 13.0	27270910
ECLASS 14.0	27270910
ECLASS 15.0	27270910
ECLASS 16.0	27270910
ETIM 5.0	EC002549
ETIM 6.0	EC002549
ETIM 7.0	EC002549
ETIM 8.0	EC002549
ETIM 9.0	EC002549
ETIM 10.0	EC002549
UNSPSC 26.08	39121528

Dimensioned drawings

All dimensions in millimeters

Light curtain transmitter and receiver



- | | | | |
|---|--|---|--|
| A | Beam spacing 5 mm | L | Profile length 1 = 648 mm
Profile length 2 = 968 mm |
| B | Measurement field length 1 = 640 mm
Measurement field length 2 = 960 mm | T | Transmitter |
| F | M6 thread | R | Receiver |
| G | Fastening groove | Y | 2.5 mm |

Dimensioned drawings

Switch cabinet

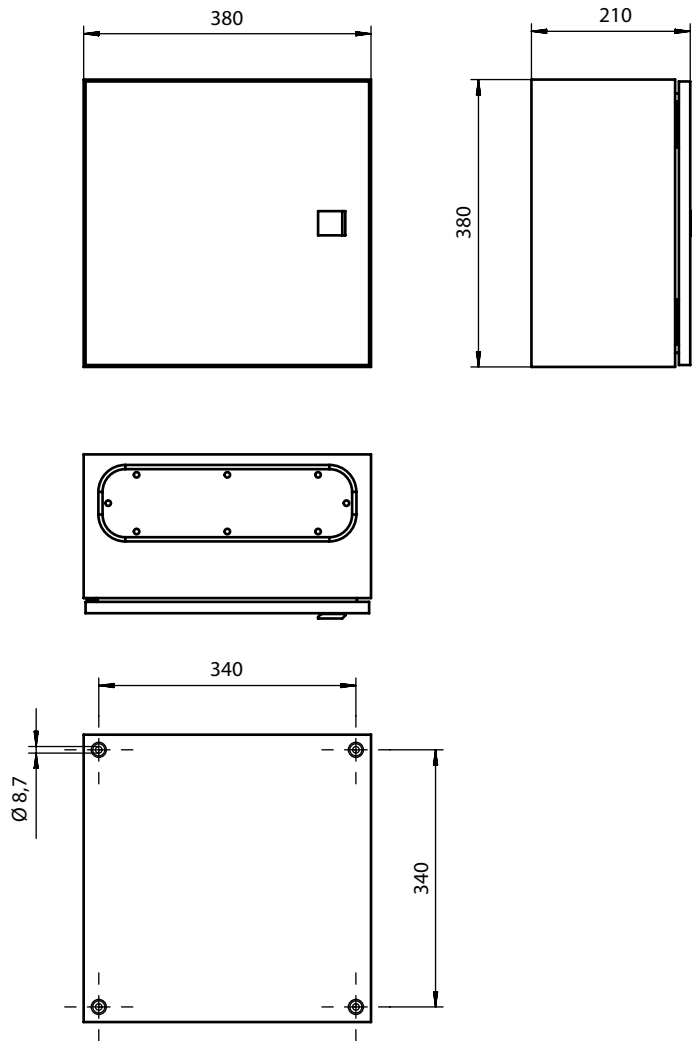

Dimensioned drawings

Rotary encoders

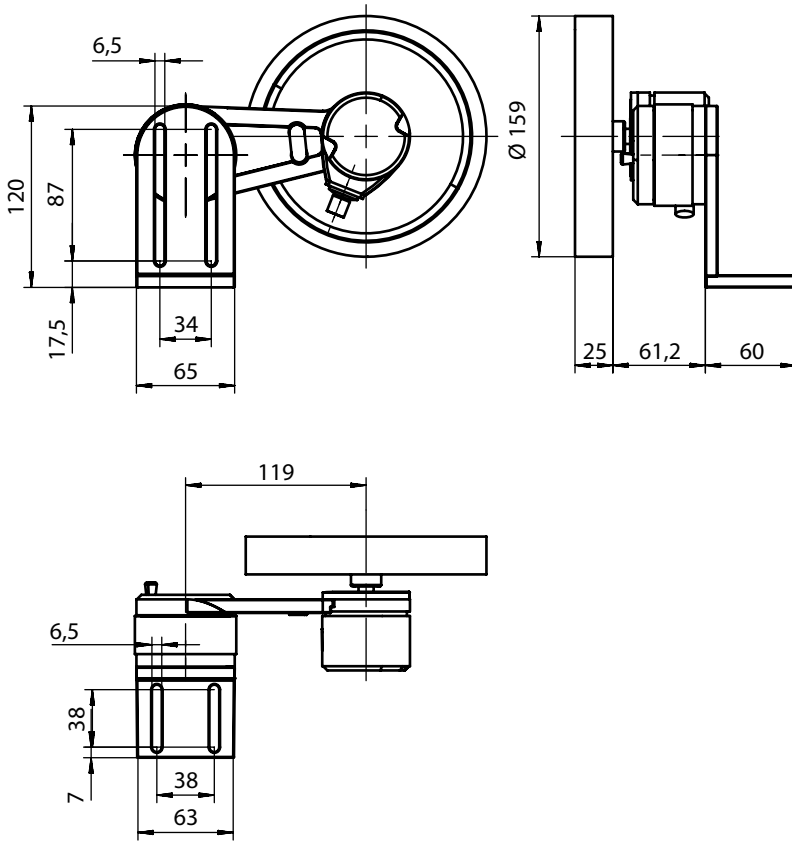

Dimensioned drawings

Mounting bracket



Electrical connection

Connection 1

Function	Earthing
Type of connection	Screw fitting
Material	Metal

Connection 2

Function	Voltage supply
Type of connection	Mains plug
Material	Metal

Connection 3

ETH1

Function	Width measuring light curtain connection
Type of connection	Connector
Thread size	M12
Type	Female
Material	Metal
No. of pins	4 -pin
Encoding	D-coded

Electrical connection

Pin	Pin assignment
1	TD+
2	RD+
3	TD-
4	RD-



Connection 4	CML1 / CML2 / CML3
Function	Height measuring light curtain connection
Type of connection	Connector
Thread size	M12
Type	Female
Material	Metal
No. of pins	8 -pin
Encoding	A-coded

Pin	Pin assignment
1	V+
2	IO1
3	GND
4	IO-Link
5	IO2
6	IO3
7	IO4
8	GND

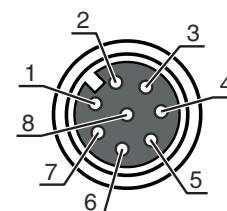

Connection 5	Encoder
Function	Rotary encoder connection (not in combination with length measuring light curtain)
Type of connection	Connector
Thread size	M12
Type	Female
Material	Metal
No. of pins	8 -pin
Encoding	A-coded

Pin	Pin assignment
1	U-
2	U+
3	A
4	B
5	N
6	A inv.
7	B inv.
8	N inv.
9	Shield

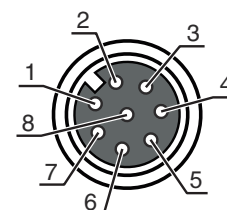

Connection 6	DI1
Function	External Ethernet TCP/IP connection
Type of connection	Connector
Thread size	M12
Type	Female
Material	Metal
No. of pins	4 -pin
Encoding	A-coded

Electrical connection

Pin	Pin assignment
1	+24 V
2	DI1
3	GND
4	DI2

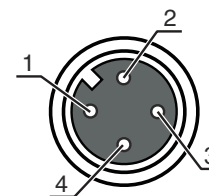

Connection 7	DI2
Function	PROFINET IN connection (optional)
Type of connection	Connector
Thread size	M12
Type	Female
Material	Metal
No. of pins	4 -pin
Encoding	A-coded

Pin	Pin assignment
1	+24 V
2	DI3
3	GND
4	DI4

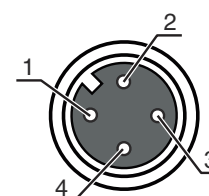

Connection 8	
Type of connection	Connector
Thread size	M12
Type	Female
Material	Metal
No. of pins	4 -pin
Encoding	A-coded

Pin	Pin assignment
1	+24 V
2	DO1
3	GND
4	DO2

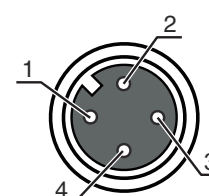

Connection 9	
Type of connection	Connector
Thread size	M12
Type	Female
Material	Metal
No. of pins	4 -pin
Encoding	A-coded

Pin	Pin assignment
1	+24 V
2	DO3
3	GND
4	DO4

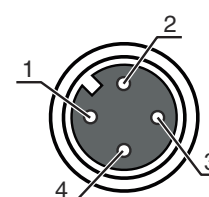

Diagrams



x Total measuring length from width and height measuring light curtain [mm]
 y Max. conveyor speed [m/s]

Notes

! Observe intended use!

- This product is not a safety sensor and is not intended as personnel protection.
- The product may only be put into operation by competent persons.
- Only use the product in accordance with its intended use.

Accessories



Connection technology - Interconnection cables

	Part no.	Designation	Article	Description
	50135082	KSS ET-M12-4A-RJ45-A-P7-100	Interconnection cable	Application: Oil and lubricant resistant Suitable for interface: Ethernet Connection 1: Connector, M12, Axial, Male, D-coded, 4 -pin Connection 2: RJ45 Shielded: Yes Cable length: 10,000 mm Sheathing material: PUR

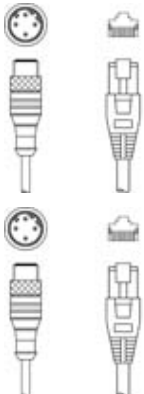
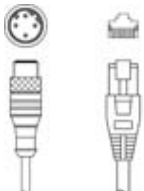
Accessories

	Part no.	Designation	Article	Description
	50135083	KSS ET-M12-4A-RJ45-A-P7-150	Interconnection cable	Application: Oil and lubricant resistant Suitable for interface: Ethernet Connection 1: Connector, M12, Axial, Male, D-coded, 4 -pin Connection 2: RJ45 Shielded: Yes Cable length: 15,000 mm Sheathing material: PUR
	50135084	KSS ET-M12-4A-RJ45-A-P7-300	Interconnection cable	Application: Oil and lubricant resistant Suitable for interface: Ethernet Connection 1: Connector, M12, Axial, Male, D-coded, 4 -pin Connection 2: RJ45 Shielded: Yes Cable length: 30,000 mm Sheathing material: PUR

Mounting technology - Other

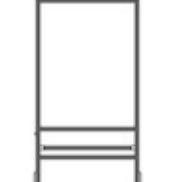
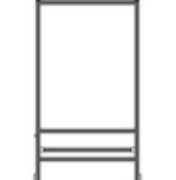
	Part no.	Designation	Article	Description
	50143670	BT 708M-MRSET	Mounting device set	Contains: Mounting material, Mounting profiles Design of mounting device: Profile kit Fastening, at system: Screw type / vertical Mounting bracket, at device: Groove mounting Type of mounting device: Rigid Material: Aluminum Shock absorber: No
	50143671	BT 70EM-MRSET	Mounting device set	Contains: Mounting material, Mounting profiles Design of mounting device: Profile kit Fastening, at system: Screw type / vertical Mounting bracket, at device: Groove mounting Type of mounting device: Rigid Material: Aluminum Shock absorber: No
	50143669	BT 710M-MRSET	Mounting device set	Contains: Mounting profiles, Mounting material Design of mounting device: Profile kit Fastening, at system: Screw type / vertical Mounting bracket, at device: Groove mounting Type of mounting device: Rigid Material: Aluminum Shock absorber: No
	50142039	BT 712M-MRSET	Mounting device set	Contains: Mounting profiles, Mounting material Design of mounting device: Profile kit Fastening, at system: Screw type / vertical Mounting bracket, at device: Groove mounting Type of mounting device: Rigid Material: Aluminum Shock absorber: No

Note



A list with all available accessories can be found on the Leuze website in the Download tab of the article detailed page.