

Technical data sheet

Polarized retro-reflective photoelectric sensor

Part no.: 50150329

PRK35CPP/LG-200-M12



Contents

- Technical data
- Dimensioned drawings
- Electrical connection
- Diagrams
- Operation and display
- Reflectors & reflective tapes
- Part number code
- Notes
- Further information
- Accessories



Technical data

Basic data

| | |
|---------------------|----------------------|
| Series | 35C |
| Operating principle | Reflection principle |

Optical data

| | |
|--------------------------|--|
| Operating range | 0.05 ... 14 m (guaranteed operating range), With reflector TK(S) 100x100 |
| Operating range limit | 0.05 ... 16 m (typical operating range), With reflector TK(S) 100x100 |
| Light source | Power PinPoint® LED, Red |
| Wavelength | 660 nm |
| Transmitted-signal shape | Pulsed |
| LED group | Exempt group (in acc. with EN 62471) |

Electrical data

| | |
|--------------------|---|
| Protective circuit | Polarity reversal protection Short circuit protected |
|--------------------|---|

Performance data

| | |
|----------------------|--|
| Supply voltage U_B | 10 ... 30 V, DC, Incl. residual ripple |
| Residual ripple | 0 ... 15 %, From U_B |
| Open-circuit current | 0 ... 20 mA |

Outputs

| | |
|-------------------------------------|------------|
| Number of digital switching outputs | 2 Piece(s) |
|-------------------------------------|------------|

Switching outputs

| | |
|-------------------------|---|
| Type | Digital switching output |
| Voltage type | DC |
| Switching current, max. | 100 mA |
| Switching voltage | high: $\geq(U_B - 2.5V)$ low: $\leq 2.5 V$ |

Switching output 1

| | |
|---------------------|--|
| Assignment | Connection 1, pin 4 |
| Switching element | Transistor, Push-pull |
| Switching principle | IO-Link / light switching (PNP)/dark switching (NPN) |

Switching output 2

| | |
|---------------------|--|
| Assignment | Connection 1, pin 2 |
| Switching element | Transistor, Push-pull |
| Switching principle | Dark switching (PNP)/light switching (NPN) |

Time behavior

| | |
|---------------------|----------|
| Switching frequency | 1,500 Hz |
| Response time | 0.2 ms |
| Readiness delay | 300 ms |

Interface

| | |
|------------------|----------------------|
| Type | IO-Link |
| IO-Link | |
| COM mode | COM2 |
| Profile | Smart sensor profile |
| Min. cycle time | COM2 = 2.3 ms |
| Frame type | 2.5 |
| Specification | V1.1 |
| Device ID | 6135 |
| SIO-mode support | Yes |

Connection

| | |
|-----------------------|------------|
| Number of connections | 1 Piece(s) |
|-----------------------|------------|

Connection 1

| | |
|--------------------|---|
| Function | Signal IN Signal OUT Voltage supply |
| Type of connection | Cable with connector |
| Cable length | 200 mm |
| Sheathing material | PVC |
| Cable color | Black |
| Wire cross section | 0.2 mm ² |
| Thread size | M12 |
| Type | Male |
| Material | Stainless steel |
| No. of pins | 4 -pin |
| Encoding | A-coded |

Mechanical data

| | |
|---------------------------------|--|
| Dimension (W x H x L) | 18.8 mm x 55.3 mm x 32.4 mm |
| Housing material | Stainless steel |
| Material of operational control | Plastic (POM Hostaform C9021, copoly-ester Tritan TX1001), non-diffusive |
| Housing roughness | Ra $\leq 0,8$, Typical value for the stainless steel housing |
| Stainless steel housing | AISI 316L, DIN X2CrNiMo17132, W. No1.4404 |
| Lens cover material | Plastic (PMMA+) with scratch-resistant Indium protective coating |
| Net weight | 120 g |
| Housing color | Silver |
| Type of fastening | Through-hole mounting Via optional mounting device |
| Compatibility of materials | CleanProof+ ECOLAB Johnson Diversey |

Operation and display

| | |
|-----------------|------------|
| Type of display | LED |
| Number of LEDs | 2 Piece(s) |

Environmental data

| | |
|--------------------------------|--------------------------------------|
| Ambient temperature, operation | -40 ... 60 °C, (70 °C ≤ 15 min) |
| Ambient temperature, storage | -40 ... 70 °C |

Certifications

| | |
|----------------------|--------------------------|
| Degree of protection | IP 67 IP 68 IP 69K |
| Protection class | III |
| Approvals | c UL US |
| Standards applied | IEC 60947-5-2 |

Technical data

| | |
|-----------------------|----------|
| Customs tariff number | 85365019 |
| ECLASS 5.1.4 | 27270902 |
| ECLASS 8.0 | 27270902 |
| ECLASS 9.0 | 27270902 |
| ECLASS 10.0 | 27270902 |
| ECLASS 11.0 | 27270902 |
| ECLASS 12.0 | 27270902 |
| ECLASS 13.0 | 27270902 |
| ECLASS 14.0 | 27270902 |
| ECLASS 15.0 | 27270902 |
| ETIM 5.0 | EC002717 |
| ETIM 6.0 | EC002717 |
| ETIM 7.0 | EC002717 |
| ETIM 8.0 | EC002717 |
| ETIM 9.0 | EC002717 |
| ETIM 10.0 | EC002717 |

Dimensioned drawings

All dimensions in millimeters

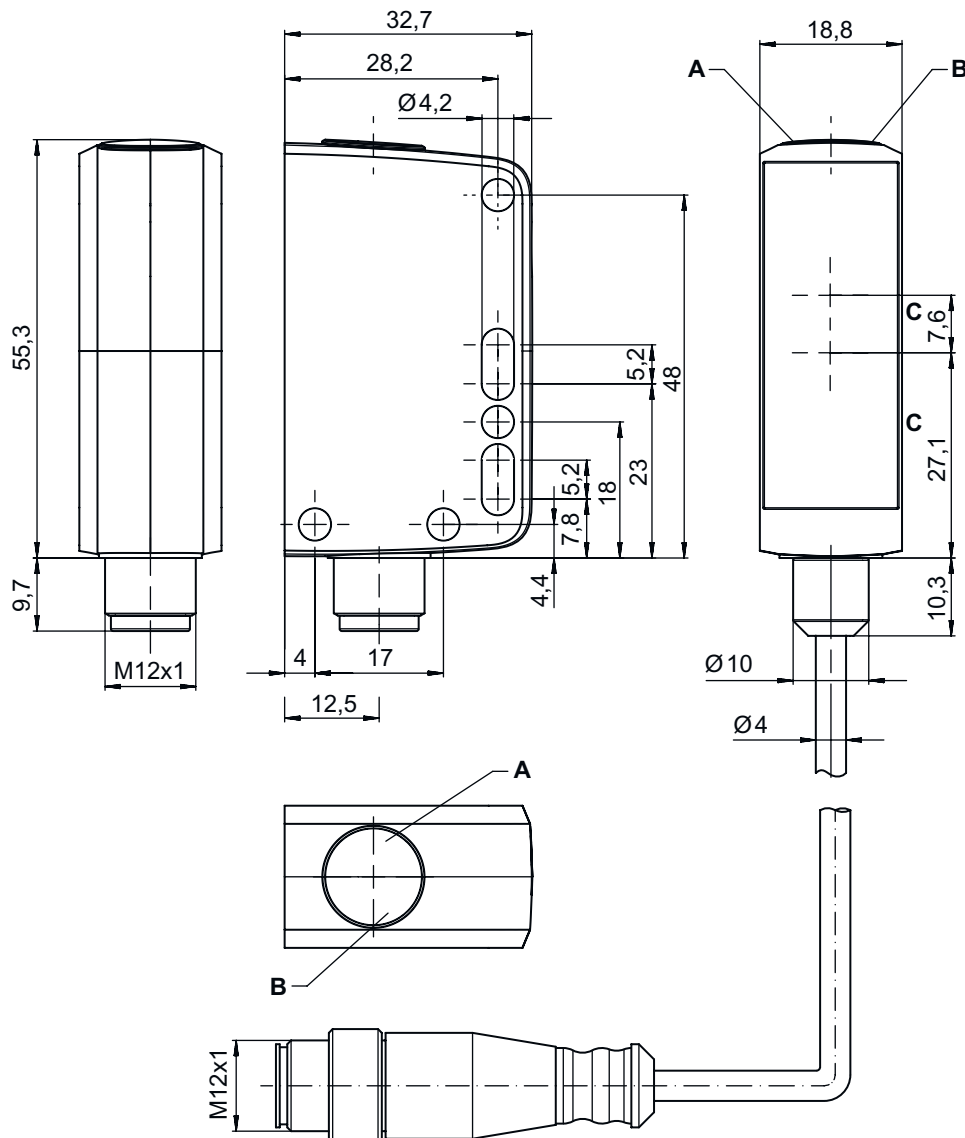

- A Green LED
- B Yellow LED
- C Optical axis
- D Potentiometer

Electrical connection

Connection 1

| | |
|--------------------|----------------------|
| Function | Signal IN |
| | Signal OUT |
| | Voltage supply |
| Type of connection | Cable with connector |
| Cable length | 200 mm |
| Sheathing material | PVC |
| Cable color | Black |

Electrical connection

Connection 1

| | |
|--------------------|---------------------|
| Wire cross section | 0.2 mm ² |
| Thread size | M12 |
| Type | Male |
| Material | Stainless steel |
| No. of pins | 4 -pin |
| Encoding | A-coded |

| Pin | Pin assignment |
|-----|-----------------|
| 1 | V+ |
| 2 | OUT 2 |
| 3 | GND |
| 4 | IO-Link / OUT 1 |

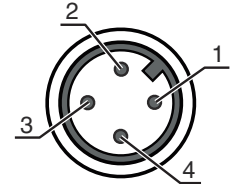

Diagrams

Typ. response behavior (TKS100x100)

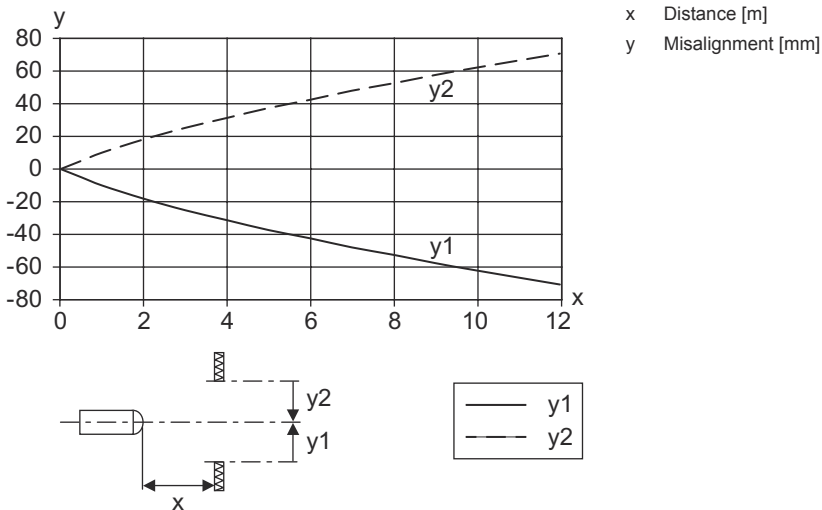



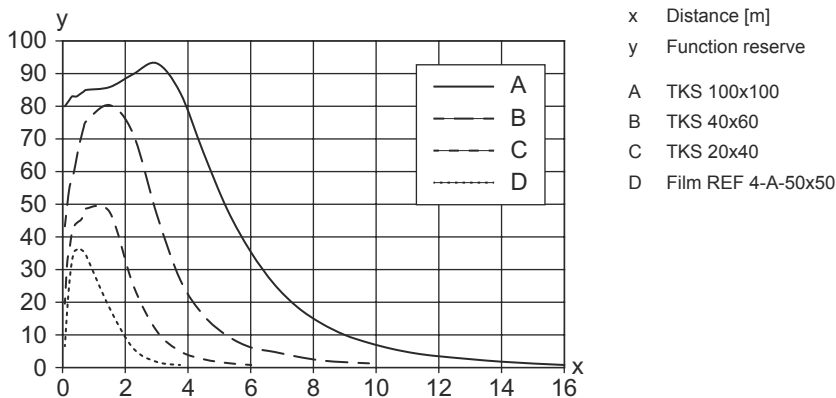



Typ. function reserve



Operation and display

| LED | Display | Meaning |
|-----|--------------------------|--------------------------------------|
| 1 | Green, continuous light | Operational readiness |
| 2 | Yellow, continuous light | Light path free |
| | Yellow, flashing | Light path free, no function reserve |



Reflectors & reflective tapes

| | Part no. | Designation | Operating range Operating range limit | Description |
|---|----------|---------------|---|--|
|  | 50136824 | MTKS 12x20M.5 | 0.12 ... 3 m 0.1 ... 3.6 m | Design: Rectangular Triple reflector size: 0.3 mm Reflective surface: 12 mm x 20 mm Material: Plastic Base material: Stainless steel Fastening: Through-hole mounting Compatibility of materials: Alcohol, CleanProof+, ECOLAB, H2O2 |
|  | 50106961 | MTKS 14x23.P | 0.1 ... 2 m 0.1 ... 2.5 m | Design: Rectangular Triple reflector size: 12 mm Reflective surface: 11 mm x 21 mm Material: Plastic Base material: Plastic Chemical designation of the material: PES Fastening: Through-hole mounting, Adhesive Compatibility of materials: ECOLAB |
|  | 50151449 | MTKS 20x20.SC | 0.17 ... 1 m 0.1 ... 1.3 m | Design: Rectangular Triple reflector size: 1.1 mm Reflective surface: 20 mm x 20 mm Material: Plastic Base material: Plastic Chemical designation of the material: Solidchem Fastening: Through-hole mounting, Adhesive Compatibility of materials: Alcohol, ECOLAB, H2O2 |
|  | 50117583 | MTKS 50x50.1 | 0.05 ... 10 m 0.05 ... 11 m | Design: Rectangular Triple reflector size: 1.2 mm Reflective surface: 50 mm x 50 mm Material: Plastic Base material: Plastic Chemical designation of the material: PMMA8N Fastening: Through-hole mounting, Adhesive |
|  | 50136823 | MTKS 7x7M.5 | 0.25 ... 1.5 m 0.2 ... 2 m | Design: Rectangular Triple reflector size: 0.3 mm Reflective surface: 7 mm x 7 mm Material: Plastic Base material: Stainless steel Fastening: Through-hole mounting Compatibility of materials: Alcohol, CleanProof+, ECOLAB, H2O2 |
|  | 50108300 | REF 4-A-50x50 | 0.18 ... 3 m 0.15 ... 3.5 m | Design: Rectangular Reflective surface: 50 mm x 50 mm Material: Plastic Chemical designation of the material: PMMA Fastening: Self-adhesive |
|  | 50110192 | REF 6-A-50x50 | 0.15 ... 6.5 m 0.12 ... 7.5 m | Design: Rectangular Triple reflector size: 0.3 mm Reflective surface: 50 mm x 50 mm Material: Plastic Chemical designation of the material: PMMA Fastening: Self-adhesive |

Reflectors & reflective tapes

| | Part no. | Designation | Operating range Operating range limit | Description |
|---|----------|----------------|---|--|
|  | 50116939 | TK 10.P | 0.35 ... 1 m 0.3 ... 1.2 m | Design: Round Triple reflector size: 1.5 mm Reflective surface, diameter: 8.5 mm Material: Plastic Base material: Plastic Chemical designation of the material: PES Fastening: Rear side can be glued Compatibility of materials: ECOLAB |
|  | 50022816 | TKS 100X100 | 0.05 ... 14 m 0.05 ... 16 m | Design: Rectangular Triple reflector size: 4 mm Reflective surface: 96 mm x 96 mm Material: Plastic Base material: Plastic Chemical designation of the material: PMMA8N Fastening: Through-hole mounting, Adhesive |
|  | 50106958 | TKS 20.P | 0.05 ... 2 m 0.05 ... 2.5 m | Design: Round Triple reflector size: 2.3 mm Reflective surface, diameter: 17 mm Material: Plastic Base material: Plastic Chemical designation of the material: PES Fastening: M4 threaded pin Compatibility of materials: ECOLAB |
|  | 50081283 | TKS 20X40 | 0.05 ... 4.5 m 0.05 ... 5.2 m | Design: Rectangular Triple reflector size: 2.3 mm Reflective surface: 16 mm x 38 mm Material: Plastic Base material: Plastic Chemical designation of the material: PMMA8N Fastening: Through-hole mounting, Adhesive |
|  | 50106960 | TKS 20x40.P | 0.05 ... 2.8 m 0.05 ... 3.2 m | Design: Rectangular Triple reflector size: 2.3 mm Reflective surface: 16 mm x 38 mm Material: Plastic Base material: Plastic Chemical designation of the material: PES Fastening: Through-hole mounting, Adhesive Compatibility of materials: ECOLAB |
|  | 50040820 | TKS 40X60 | 0.05 ... 8.5 m 0.05 ... 10 m | Design: Rectangular Triple reflector size: 4 mm Reflective surface: 37 mm x 56 mm Material: Plastic Base material: Plastic Chemical designation of the material: PMMA8N Fastening: Through-hole mounting, Adhesive |
|  | 50120538 | TKS 40x60.1.AF | 0.05 ... 7.5 m 0.05 ... 8.5 m | Special version: Anti-fog coating Design: Rectangular Triple reflector size: 2.3 mm Reflective surface: 37 mm x 56 mm Material: Plastic Base material: Plastic Chemical designation of the material: PMMA8N Fastening: Through-hole mounting, Adhesive |
|  | 50136383 | TKS 40x60.Chem | 0.05 ... 5.5 m 0.05 ... 6.5 m | Design: Rectangular Triple reflector size: 4 mm Reflective surface: 37 mm x 56 mm Material: Plastic Base material: Plastic Chemical designation of the material: PET Fastening: Through-hole mounting, Adhesive Compatibility of materials: Alcohol, ECOLAB, H2O2 |

Reflectors & reflective tapes

| | Part no. | Designation | Operating range Operating range limit | Description |
|---|----------|----------------|---|--|
|  | 50106957 | TKS 40x60.P | 0.05 ... 6 m 0.05 ... 7 m | Design: Rectangular Triple reflector size: 4 mm Reflective surface: 37 mm x 56 mm Material: Plastic Base material: Plastic Chemical designation of the material: PES Fastening: Through-hole mounting, Adhesive Compatibility of materials: ECOLAB |
|  | 50151448 | TKS 50x50.1.SC | 0.05 ... 4 m 0.05 ... 5 m | Design: Rectangular Triple reflector size: 4 mm Reflective surface: 51.3 mm x 51.2 mm Material: Plastic Base material: Plastic Chemical designation of the material: Solidchem Fastening: Adhesive, Through-hole mounting Compatibility of materials: Alcohol, ECOLAB, H2O2 |

Part number code

Part designation: **AAA35C d EE.GGH/iJ-K**

| | |
|---------------|---|
| AAA35C | Operating principle LS35C: Throughbeam photoelectric sensor transmitter LE35C: Throughbeam photoelectric sensor receiver PRK35C: Retro-reflective photoelectric sensor with polarization filter HT35C: Diffuse reflection sensor with background suppression DRT35C: Dynamic reference diffuse sensor |
| d | Light type n/a: red light l: infrared light |
| EE | Light source n/a: LED PP: Power PinPoint® LED L1: laser class 1 |
| GG | Equipment A: Autocollimation principle (single lens) D: Detection of stretch-wrapped objects X: extended model XL: Extra long light spot TT: autocollimation principle (single lens) for highly transparent bottles with tracking R: greater operating range XXR: super power transmitter |
| H | Operating range adjustment 1: 270° potentiometer 2: multiturn potentiometer 3: teach-in via button |
| i | Switching output/function OUT 1/IN: Pin 4 or black conductor X: pin not used 8: activation input (activation with high signal) L: IO-Link interface (SIO mode: PNP light switching, NPN dark switching) 4: PNP transistor output, light switching 6: push-pull switching output, PNP light switching, NPN dark switching 1: IO-Link / light switching (NPN) / dark switching (PNP) |

Part number code

| | |
|----------|---|
| J | Switching output / function OUT 2/IN: pin 2 or white conductor T: teach-in via cable G: Push-pull switching output, PNP dark switching, NPN light switching X: pin not used P: PNP transistor output, dark switching 6: push-pull switching output, PNP light switching, NPN dark switching |
|----------|---|

| | |
|----------|--|
| K | Electrical connection n/a: cable, standard length 2000 mm, 4-wire 200-M12: cable, length 200 mm with M12 connector, 4-pin, axial (plug) M12: M12 connector, 4-pin (plug) |
|----------|--|

Note

| | |
|--|--|
| | ⓘ A list with all available device types can be found on the Leuze website at www.leuze.com . |
|--|--|

Notes

Observe intended use!

| | |
|--|---|
| | ⓘ This product is not a safety sensor and is not intended as personnel protection. ⓘ The product may only be put into operation by competent persons. ⓘ Only use the product in accordance with its intended use. |
|--|---|

Further information

- Ambient temperature, operation: +70 °C permissible only briefly (≤ 15min)
- IP 69K only in combination with connector
- Light source: Average life expectancy 100,000h at an ambient temperature of 25 °C
- Sum of the output currents for both outputs 100 mA

Accessories

Connection technology - Connection unit

| | Part no. | Designation | Article | Description |
|--|----------|-----------------------|----------------|---|
| | 50144900 | MD 798i-11-82/L5-2222 | IO-Link master | Current consumption, max.: 11,000 mA Interface: IO-Link, Automatic protocol detection, EtherNet IP, Modbus TCP, PROFINET Connections: 12 Piece(s) Sensor connections: 8 Piece(s) Degree of protection: IP 67, IP 65, IP 69K |

Accessories

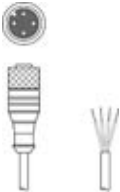
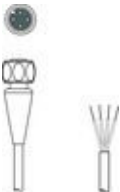
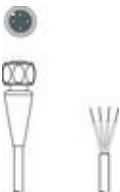

Connection technology - Connection cables

| | Part no. | Designation | Article | Description |
|---|----------|------------------------|------------------|--|
|  | 50130657 | KD U-M12-4A-P1-050 | Connection cable | Application: Oil and lubricant resistant Connection 1: Connector, M12, Axial, Female, A-coded, 4 -pin Connector, LED: No Connection 2: Open end Shielded: No Cable length: 5,000 mm Sheathing material: PUR |
|  | 50148349 | KD U-M12-4A-T0-020 F+B | Connection cable | Application: Hygienic and wet areas, Chemical resistant Connection 1: Connector, M12, Axial, Female, A-coded, 4 -pin Connector, LED: No Connection 2: Open end Shielded: No Cable length: 2,000 mm Sheathing material: TPE |
|  | 50148350 | KD U-M12-4A-T0-050 F+B | Connection cable | Application: Chemical resistant, Hygienic and wet areas Connection 1: Connector, M12, Axial, Female, A-coded, 4 -pin Connector, LED: No Connection 2: Open end Shielded: No Cable length: 5,000 mm Sheathing material: TPE |

Mounting technology - Mounting brackets

| | Part no. | Designation | Article | Description |
|---|----------|-------------|------------------|---|
|  | 50118543 | BT 300M.5 | Mounting bracket | Design of mounting device: Angle, L-shape Fastening, at system: Through-hole mounting Mounting bracket, at device: Screw type, Suited for M4 screws Type of mounting device: Adjustable Material: Stainless steel |

Mounting technology - Rod mounts

| | Part no. | Designation | Article | Description |
|---|----------|----------------|-----------------|---|
|  | 50117252 | BTU 300M-D12 | Mounting system | Contains: 2x M4 x 25 screw, 2x M4 x 20 screw, 4x position washers Design of mounting device: Mounting system Fastening, at system: For 12 mm rod, Sheet-metal mounting Mounting bracket, at device: Screw type, Suited for M4 screws Type of mounting device: Clampable, Adjustable, Turning, 360° Material: Metal |
|  | 50120425 | BTU 300M.5-D12 | Mounting system | Contains: 2x M4 x 25 screw, 2x M4 mounting nut, 2x M4 x 20 screw, 2x position washers Design of mounting device: Mounting system Fastening, at system: For 12 mm rod, Sheet-metal mounting Mounting bracket, at device: Screw type, Suited for M4 screws Type of mounting device: Clampable, Adjustable, Turning, 360° Material: Stainless steel |

Accessories

Note



🔗 A list with all available accessories can be found on the Leuze website in the Download tab of the article detailed page.