

HRTR 3B V Diffuse reflection light scanner with V-optics and background suppression

en 03-2014/05 50115120-01

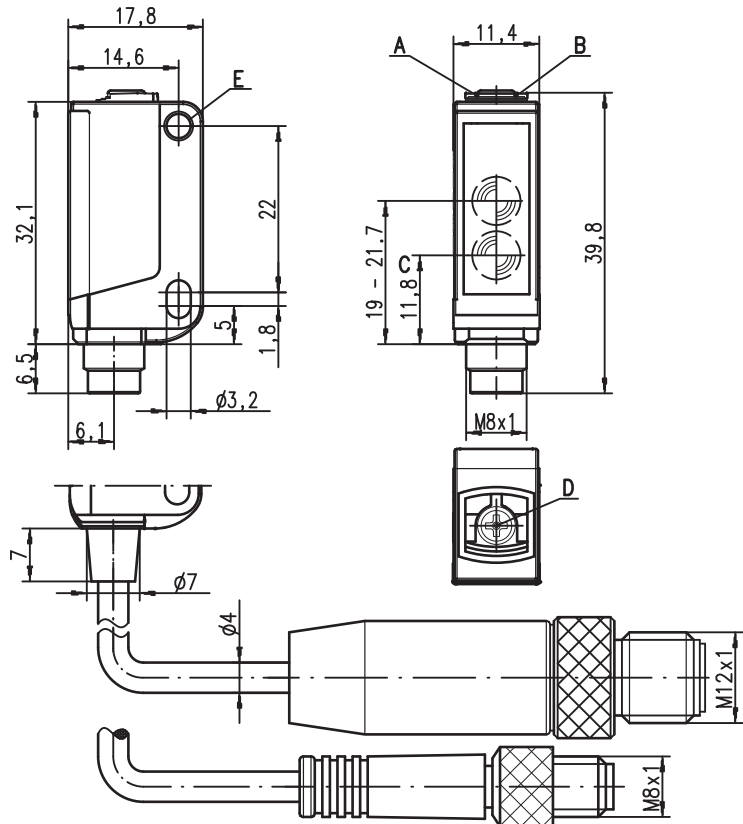

Dimensioned drawing



- A** Green indicator diode
- B** Yellow indicator diode
- C** Optical axis
- D** 8-turn potentiometer for scanning range adjustment
- E** Attachment sleeve

15 ... 200mm
100mm with
black-white error < 10%

1 kHz

10 - 30 V
DC

A²LS

ASIC

- Diffuse reflection light scanner with visible red light, V-optics and adjustable background suppression
- Thanks to V-optics, it is specially suited to the detection of very shiny or polished surfaces in a range of 30 ... 70mm
- Very good black-white behavior and precise background suppression
- Exact scanning range adjustment through 8-turn potentiometer
- High switching frequency for detection of fast events
- Also available in economy design

Electrical connection

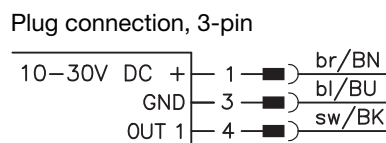
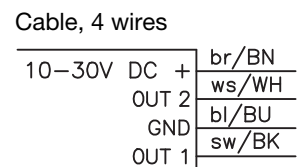
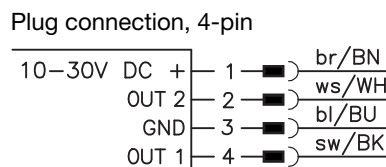

Accessories:

- (available separately)
- Mounting systems (BT 3...)
 - Cable with M8 or M12 connector (K-D ...)

We reserve the right to make changes • DS_HRTR3BV_en_50115120_01.fm

Specifications

Optical data

Scanning range ¹⁾ 15 ... 200mm
 Adjustment range ¹⁾ 20 ... 200mm
 Black/white error < 10% up to 100mm
 Light beam exit angle typ. 11°
 Light beam characteristic focussed at 200mm
 Light source ²⁾ LED (modulated light)
 Wavelength 620nm (visible red light)

Timing

Switching frequency 1,000Hz
 Response time 0.5ms
 Delay before start-up ≤ 300ms (acc. to. IEC 60947-5-2)

Electrical data

Operating voltage U_B ³⁾ 10 ... 30VDC (incl. residual ripple)
 Residual ripple ≤ 15% of U_B
 Open-circuit current ≤ 15mA
 Switching output .../66 ⁴⁾ 2 push-pull switching outputs
 pin 2: PNP dark switching, NPN light switching
 pin 4: PNP light switching, NPN dark switching
 Function characteristics light/dark switching
 Signal voltage high/low ≥ ($U_B - 2V$) / ≤ 2V
 Output current max. 100mA
 Scanning range adjustable via 8-turn potentiometer

Indicators

Green LED ⁵⁾ ready
 Yellow LED object detected - reflection

Mechanical data

Housing plastic (PC-ABS); 1 attachment sleeve, nickel-plated steel ⁵⁾
 Housing color red, RAL 3000
 Optics cover plastic (PMMA)
 Fastening through holes for 2 x M3
 Weight with connector: 10g
 with 200mm cable and connector: 20g
 with 2m cable: 50g
 Connection type M8 connector, metal ⁶⁾,
 0.2m cable with M8 or M12 connector,
 2m cable (cross section 4x0.20mm²)

Environmental data

Ambient temp. (operation/storage) -30°C ... +55°C / -30°C ... +70°C
 Protective circuit ⁷⁾ 2, 3
 VDE safety class III
 Protection class IP 67
 Light source free group (in accordance with EN 62471)
 Standards applied IEC 60947-5-2
 Certifications UL 508, C22.2 No.14-13 ³⁾ ⁸⁾

- 1) Scanning range: recommended scanning range for objects with different diffuse reflection
- 2) Average life expectancy 100,000h at an ambient temperature of 25°C
- 3) For UL applications: for use in class 2 circuits according to NEC only
- 4) The push-pull switching outputs must not be connected in parallel
- 5) N/A for economy design
- 6) M8 plastic connector for economy design
- 7) 2=polarity reversal protection, 3=short-circuit protection for all transistor outputs
- 8) These proximity switches shall be used with UL Listed Cable assemblies rated 30V, 0.5A min, in the field installation, or equivalent (categories: CYJV/CYJV7 or PVVA/PVVA7)

Operate in accordance with intended use!

⚠ This product is not a safety sensor and is not intended as personnel protection.
 ⚠ The product may only be put into operation by competent persons.
 ⚠ Only use the product in accordance with the intended use.

Remarks

Adapter plate:

BT 3.2 (part no. 50103844) for alternate mounting on 25.4 mm hole spacing (Omron E3Z, Sick W100...)

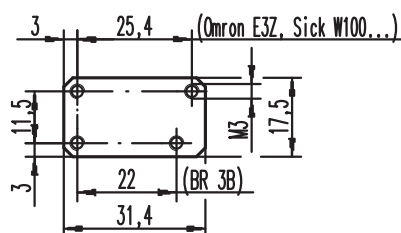

Tables

1	15	200
2	15	180
3	15	130

1	white 90%
2	gray 18%
3	black 6%

Scanning range [mm]

Diagrams

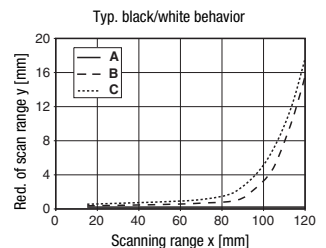
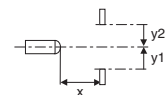
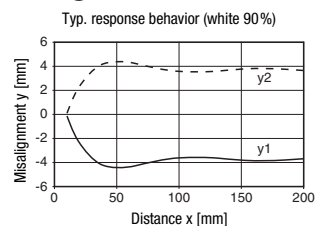

- A white 90%
- B gray 18%
- C black 6%

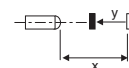

Remarks

Mounting system:



- ① = BT 3 (Part no. 50060511)
- ②+③ = BT 3.1 ¹ (Part no. 50105585)
- ①+②+③ = BT 3B (Part no. 50105546)

1)Packaging unit: PU = 10 pcs.

HRTR 3B V Diffuse reflection light scanner with V-optics and background suppression

Part number code

H	R	T	R	3	B	/	6	6	-	V	,	2	0	0	-	S	8	.	3
---	---	---	---	---	---	---	---	---	---	---	---	---	---	---	---	---	---	---	---

Operating principle

HRT Diffuse reflection light scanners with background suppression

Light type

R Red light

Construction/version

3B 3B Series

Switching output/function (OUT 1: pin 4, OUT 2: pin 2)

/66 2 x push-pull transistor output, OUT 1: light switching, OUT 2: dark switching

/6 1 x push-pull transistor output, OUT 1: light switching

/2 1 x NPN transistor output, OUT 1: light switching

Equipment

.7 Economy design

-V With V-optics

Electrical connection

N/A Cable, PVC, standard length 2000mm, 4-wire

-S8.3 M8 connector, 3 pin (plug)

-S8 M8 connector, 4 pin (plug)

,200-S8.3 Cable, PVC, length 200mm with M 8 connector, 3 pin, axial (plug)

,200-S8 Cable, PVC, length 200mm with M 8 connector, 4 pin, axial (plug)

,200-S12 Cable, PVC, length 200mm with M 12 connector, 4 pin, axial (plug)

Order guide

The sensors listed here are preferred types; current information at www.leuze.com

Order code

Part No.

HRTR 3B/66-V-S8	50114769
HRTR 3B/66-V, 200-S8	50114767
HRTR 3B/66-V, 200-S12	50114768
HRTR 3B/66-V	50114766
HRTR 3B/2.7-V	50115641

Application notes



- The sensor must be aligned vertically and parallel to the object.
- Objects should only be moved in laterally from the right or left. Moving in objects from the connector side or operating side is not permitted.

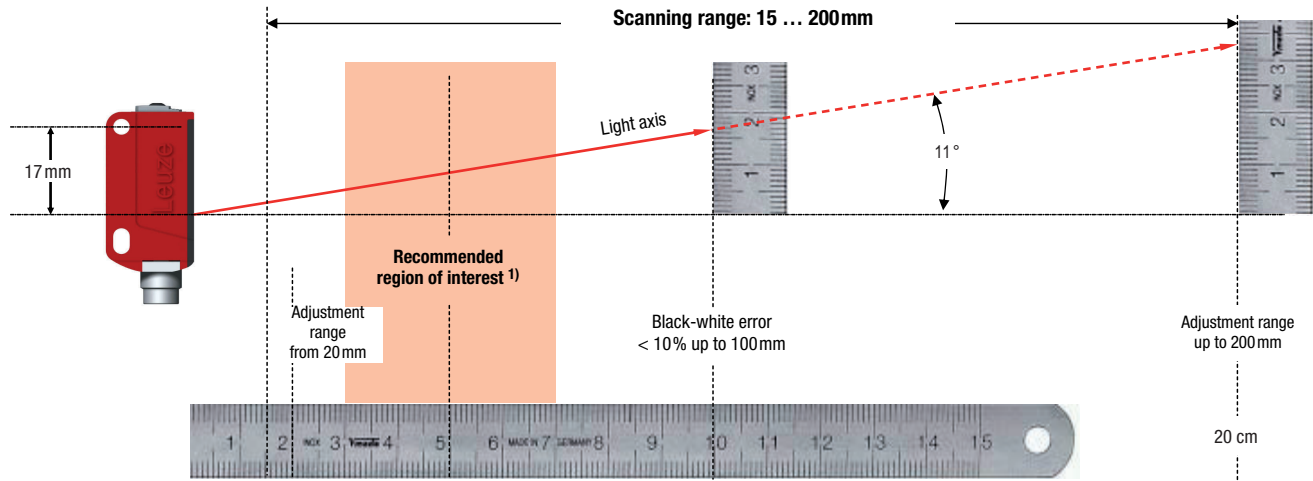

1) The ability of the sensor to reliably detect reflective surfaces or transparent objects is the strongest in the recommended working range. The sensor can also reliably detect such objects in the entire scanning range; however, the performance reserve is reduced in comparison to the recommended working range.



- Outside of the scanning range, the sensor operates as an energetic diffuse reflection light scanner. Light objects can still be reliably detected up to the scanning range limit.
- The sensors are equipped with effective measures for the maximum avoidance of mutual interference should they be mounted opposite one another. Opposite mounting of multiple sensors of the same type should, however, absolutely be avoided.