

Technical data sheet

Contour measurement system

Part no.: 50143582
CMS708i-ENC1-0640-0720

Contents

- Set consists of
- Technical data
- Dimensioned drawings
- Electrical connection
- Diagrams
- Notes
- Accessories



For illustration purposes only



Set consists of

| | Quantity | Part no. | Designation | Article | Description |
|---|----------|----------|-----------------------------|---------------------------|--|
|  | 2 | 424417 | BT-2P40 | Mounting bracket set | Contains: BT-P40 clamp bracket, 2x Bore hole 1: M6 Bore hole 2: M6 Design of mounting device: Mounting clamp Fastening, at system: Groove mounting Mounting bracket, at device: Groove mounting Type of mounting device: Clampable, Suitable for mounting in UDC-S2, DC-S2 device columns Material: Metal |
|  | 1 | 50118744 | CML730i-R05-640.A/L-M12 | Light curtain receiver | Interface: IO-Link Connection: Connector, M12, Axial, 8 -pin |
|  | 1 | 50118745 | CML730i-R05-720.A/L-M12 | Light curtain receiver | Interface: IO-Link Connection: Connector, M12, Axial, 8 -pin |
|  | 1 | 50118583 | CML730i-T05-640.A-M12 | Light curtain transmitter | Operating range: 0.1 ... 4 m Connection: Connector, M12, Axial, 5 -pin |
|  | 1 | 50118584 | CML730i-T05-720.A-M12 | Light curtain transmitter | Operating range: 0.1 ... 4 m Connection: Connector, M12, Axial, 5 -pin |
|  | 2 | 50129781 | KDS DN-M12-5A-M12-5A-P3-050 | Interconnection cable | Application: Oil and lubricant resistant Suitable for interface: DeviceNet, CANopen Connection 1: Connector, M12, Axial, Female, A-coded, 5 -pin Connection 2: Connector, M12, Axial, Male, A-coded, 5 -pin Shielded: Yes Cable length: 5,000 mm Sheathing material: PUR |
|  | 3 | 50135146 | KDS S-M12-8A-M12-8A-P1-050 | Interconnection cable | Application: Oil and lubricant resistant Connection 1: Connector, M12, Axial, Female, A-coded, 8 -pin Connection 2: Connector, M12, Axial, Male, A-coded, 8 -pin Shielded: Yes Cable length: 5,000 mm Sheathing material: PUR |
|  | 1 | 50144568 | LMSMA35500024KH 10M16 | Rotary encoder | |

Set consists of

| | Quantity | Part no. | Designation | Article | Description |
|--|----------|----------|----------------|----------------|--|
|  | 1 | 50142930 | LSC708-ENC-100 | Switch cabinet | Supply voltage: 100 ... 263 V, AC Switching inputs: 4 Piece(s) Switching outputs: 4 Piece(s) Connections: 11 Piece(s) |

Technical data

Basic data

| | |
|-------------|---------------------------------------|
| Series | CMS 7xxi |
| Contains | 1x dongle CMS700 1x rotary encoder |
| Order guide | Additional models on request |

Functions

| | |
|-----------|---|
| Functions | For a minimum object height ≥ 5 mm |
|-----------|---|

Optical data

| | |
|------------------------------------|----------------|
| Operating range | 0.1 ... 4.5 m |
| Operating range, transparent media | 0.1 ... 1.75 m |
| Operating range limit | 0.1 ... 6 m |
| Measurement field length 1 | 640 mm |
| Measurement field length 2 | 720 mm |
| Beam spacing | 5 mm |

Electrical data

| | |
|--|---|
| Protective circuit | Polarity reversal protection Short circuit protected Transient protection |
| Output current, continuous current per channel, max. | 100 mA |

Performance data

| | |
|----------------------|---------------|
| Supply voltage U_B | 100 ... 263 V |
| Open-circuit current | 250 mA |

Inputs

| | |
|------------------------------------|------------|
| Number of digital switching inputs | 4 Piece(s) |
|------------------------------------|------------|

Switching inputs

| | |
|-------------------|-------------------------|
| Type | Digital switching input |
| Voltage type | DC |
| Switching voltage | 24 V, VIN |

Outputs

| | |
|-------------------------------------|------------|
| Number of digital switching outputs | 4 Piece(s) |
|-------------------------------------|------------|

Switching outputs

| | |
|-------------------|--------------------------|
| Type | Digital switching output |
| Voltage type | AC |
| Switching voltage | 24 V, VIN |

Interface

| | |
|------|-----------------|
| Type | EtherNet TCP/IP |
|------|-----------------|

Ethernet

| | |
|----------|------------------------------|
| Function | Configuration / process data |
|----------|------------------------------|

Connection

| | |
|-----------------------|-------------|
| Number of connections | 11 Piece(s) |
|-----------------------|-------------|

Connection 1

| | |
|--------------------|---------------|
| Function | Earthing |
| Type of connection | Screw fitting |
| Material | Metal |

Connection 2

| | |
|--------------------|----------------|
| Function | Voltage supply |
| Type of connection | Mains plug |
| Material | Metal |

Connection 3

| | |
|--------------------|--|
| Function | Width measuring light curtain connection |
| Type of connection | Connector |
| Thread size | M12 |
| Type | Female |
| Material | Metal |
| No. of pins | 4 -pin |
| Encoding | D-coded |

Connection 4

| | |
|--------------------|---|
| Function | Height measuring light curtain connection |
| Type of connection | Connector |
| Thread size | M12 |
| Type | Female |
| Material | Metal |
| No. of pins | 8 -pin |
| Encoding | A-coded |

Connection 5

| | |
|--------------------|--|
| Function | Rotary encoder connection (not in combination with length measuring light curtain) |
| Type of connection | Connector |
| Thread size | M12 |
| Type | Female |
| Material | Metal |
| No. of pins | 8 -pin |
| Encoding | A-coded |

Connection 6

| | |
|--------------------|-------------------------------------|
| Function | External Ethernet TCP/IP connection |
| Type of connection | Connector |
| Thread size | M12 |
| Type | Female |
| Material | Metal |
| No. of pins | 4 -pin |
| Encoding | A-coded |

Technical data

Connection 7

| | |
|--------------------|-----------------------------------|
| Function | PROFINET IN connection (optional) |
| Type of connection | Connector |
| Thread size | M12 |
| Type | Female |
| Material | Metal |
| No. of pins | 4 -pin |
| Encoding | A-coded |

Connection 8

| | |
|--------------------|-----------|
| Type of connection | Connector |
| Thread size | M12 |
| Type | Female |
| Material | Metal |
| No. of pins | 4 -pin |
| Encoding | A-coded |

Connection 9

| | |
|--------------------|-----------|
| Type of connection | Connector |
| Thread size | M12 |
| Type | Female |
| Material | Metal |
| No. of pins | 4 -pin |
| Encoding | A-coded |

Mechanical data

| | |
|---------------------|-------------|
| Design | Cubic |
| Housing material | Metal |
| Metal housing | Aluminum |
| Lens cover material | Plastic |
| Net weight | 12,750 g |
| Housing color | Gray Red |

Note Dimensions of individual set items, see dimensioned drawings

Operation and display

| | |
|-----------------------|-------------------------|
| Type of display | LED |
| Number of LEDs | 3 Piece(s) |
| Type of configuration | performed via webConfig |
| Operational controls | Rotary switch |

Environmental data

| | |
|--------------------------------|---------------|
| Ambient temperature, operation | 0 ... 45 °C |
| Ambient temperature, storage | -20 ... 70 °C |

Classification

| | |
|-----------------------|----------|
| Customs tariff number | 90314990 |
| ECLASS 5.1.4 | 27270910 |
| ECLASS 8.0 | 27270910 |
| ECLASS 9.0 | 27270910 |
| ECLASS 10.0 | 27270910 |
| ECLASS 11.0 | 27270910 |
| ECLASS 12.0 | 27270910 |
| ECLASS 13.0 | 27270910 |
| ECLASS 14.0 | 27270910 |
| ECLASS 15.0 | 27270910 |
| ECLASS 16.0 | 27270910 |
| ETIM 5.0 | EC002549 |
| ETIM 6.0 | EC002549 |
| ETIM 7.0 | EC002549 |
| ETIM 8.0 | EC002549 |
| ETIM 9.0 | EC002549 |
| ETIM 10.0 | EC002549 |
| UNSPSC 26.08 | 39121528 |

Dimensioned drawings

All dimensions in millimeters

Light curtain transmitter and receiver

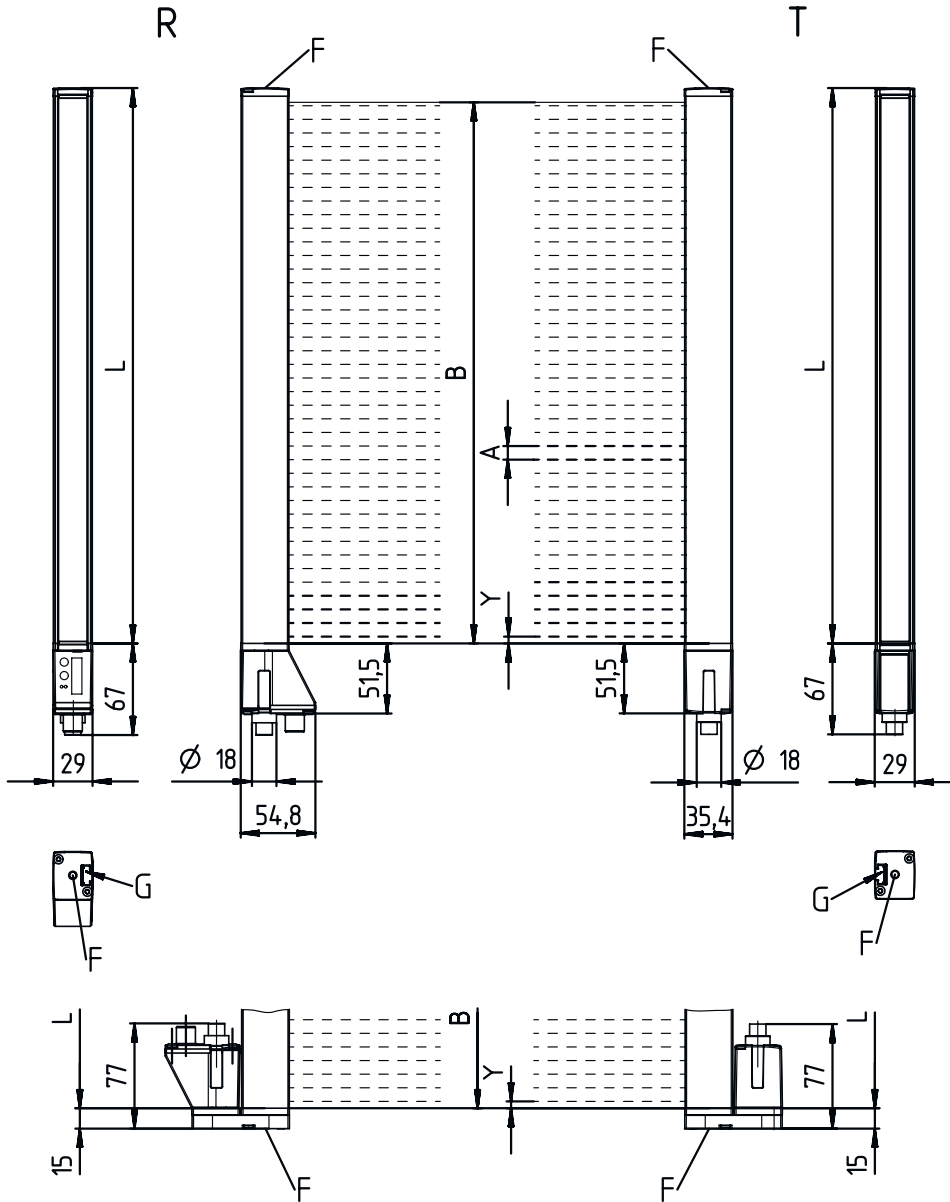

- | | | | |
|---|--|---|--|
| A | Beam spacing 5 mm | L | Profile length 1 = 648 mm Profile length 2 = 728 mm |
| B | Measurement field length 1 = 640 mm Measurement field length 2 = 720 mm | T | Transmitter |
| F | M6 thread | R | Receiver |
| G | Fastening groove | Y | 2.5 mm |

Dimensioned drawings

Switch cabinet

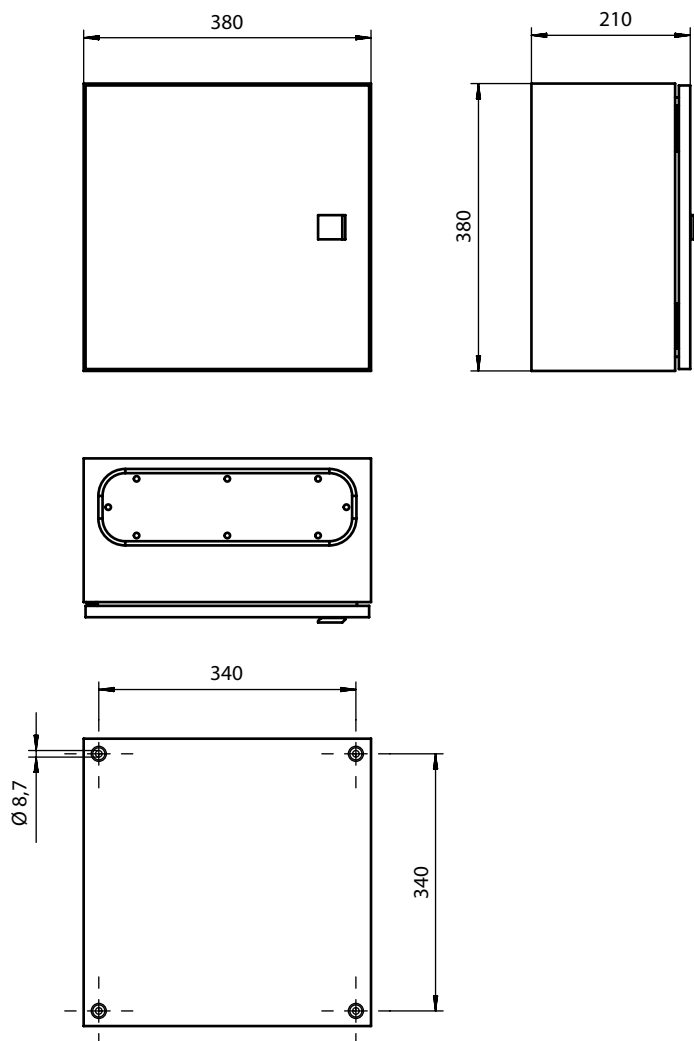

Dimensioned drawings

Rotary encoders

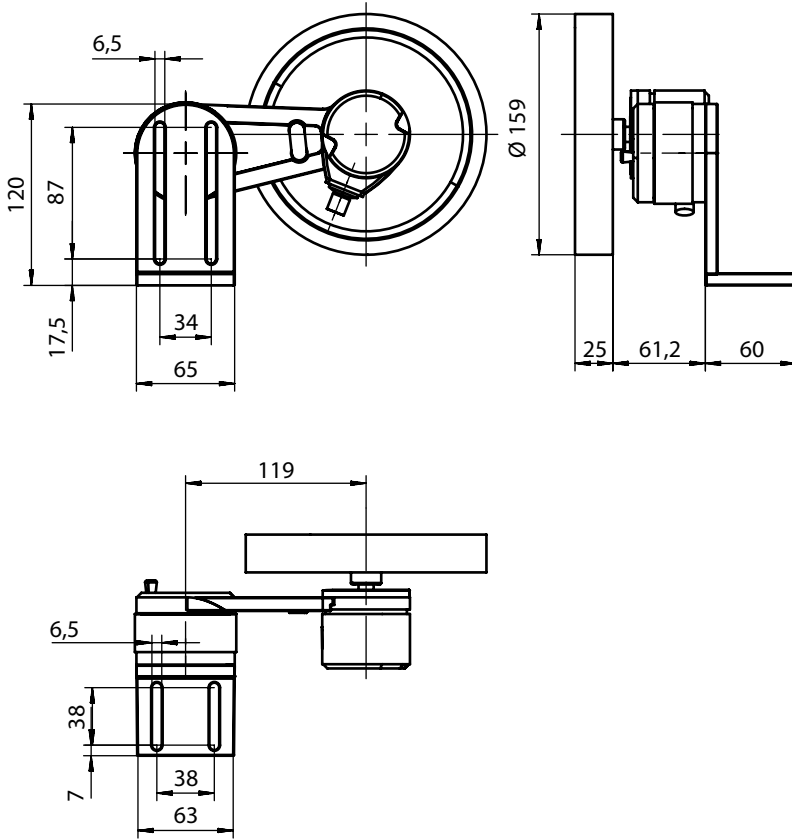

Dimensioned drawings

Mounting bracket



Electrical connection

Connection 1

| | |
|--------------------|---------------|
| Function | Earthing |
| Type of connection | Screw fitting |
| Material | Metal |

Connection 2

| | |
|--------------------|----------------|
| Function | Voltage supply |
| Type of connection | Mains plug |
| Material | Metal |

Connection 3

ETH1

| | |
|--------------------|--|
| Function | Width measuring light curtain connection |
| Type of connection | Connector |
| Thread size | M12 |
| Type | Female |
| Material | Metal |
| No. of pins | 4 -pin |
| Encoding | D-coded |

Electrical connection

| Pin | Pin assignment |
|-----|----------------|
| 1 | TD+ |
| 2 | RD+ |
| 3 | TD- |
| 4 | RD- |



| Connection 4 | CML1 / CML2 / CML3 |
|--------------------|---|
| Function | Height measuring light curtain connection |
| Type of connection | Connector |
| Thread size | M12 |
| Type | Female |
| Material | Metal |
| No. of pins | 8 -pin |
| Encoding | A-coded |

| Pin | Pin assignment |
|-----|----------------|
| 1 | V+ |
| 2 | IO1 |
| 3 | GND |
| 4 | IO-Link |
| 5 | IO2 |
| 6 | IO3 |
| 7 | IO4 |
| 8 | GND |



| Connection 5 | Encoder |
|--------------------|--|
| Function | Rotary encoder connection (not in combination with length measuring light curtain) |
| Type of connection | Connector |
| Thread size | M12 |
| Type | Female |
| Material | Metal |
| No. of pins | 8 -pin |
| Encoding | A-coded |

| Pin | Pin assignment |
|-----|----------------|
| 1 | U- |
| 2 | U+ |
| 3 | A |
| 4 | B |
| 5 | N |
| 6 | A inv. |
| 7 | B inv. |
| 8 | N inv. |
| 9 | Shield |



| Connection 6 | DI1 |
|--------------------|-------------------------------------|
| Function | External Ethernet TCP/IP connection |
| Type of connection | Connector |
| Thread size | M12 |
| Type | Female |
| Material | Metal |
| No. of pins | 4 -pin |
| Encoding | A-coded |

Electrical connection

| Pin | Pin assignment |
|-----|----------------|
| 1 | +24 V |
| 2 | DI1 |
| 3 | GND |
| 4 | DI2 |

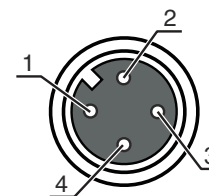

| Connection 7 | DI2 |
|--------------------|-----------------------------------|
| Function | PROFINET IN connection (optional) |
| Type of connection | Connector |
| Thread size | M12 |
| Type | Female |
| Material | Metal |
| No. of pins | 4 -pin |
| Encoding | A-coded |

| Pin | Pin assignment |
|-----|----------------|
| 1 | +24 V |
| 2 | DI3 |
| 3 | GND |
| 4 | DI4 |

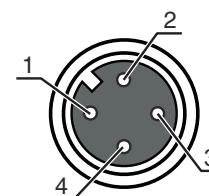

| Connection 8 | |
|--------------------|-----------|
| Type of connection | Connector |
| Thread size | M12 |
| Type | Female |
| Material | Metal |
| No. of pins | 4 -pin |
| Encoding | A-coded |

| Pin | Pin assignment |
|-----|----------------|
| 1 | +24 V |
| 2 | DO1 |
| 3 | GND |
| 4 | DO2 |

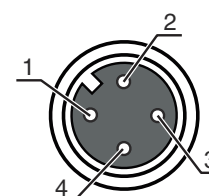

| Connection 9 | |
|--------------------|-----------|
| Type of connection | Connector |
| Thread size | M12 |
| Type | Female |
| Material | Metal |
| No. of pins | 4 -pin |
| Encoding | A-coded |

| Pin | Pin assignment |
|-----|----------------|
| 1 | +24 V |
| 2 | DO3 |
| 3 | GND |
| 4 | DO4 |

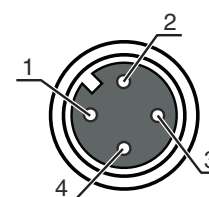

Diagrams

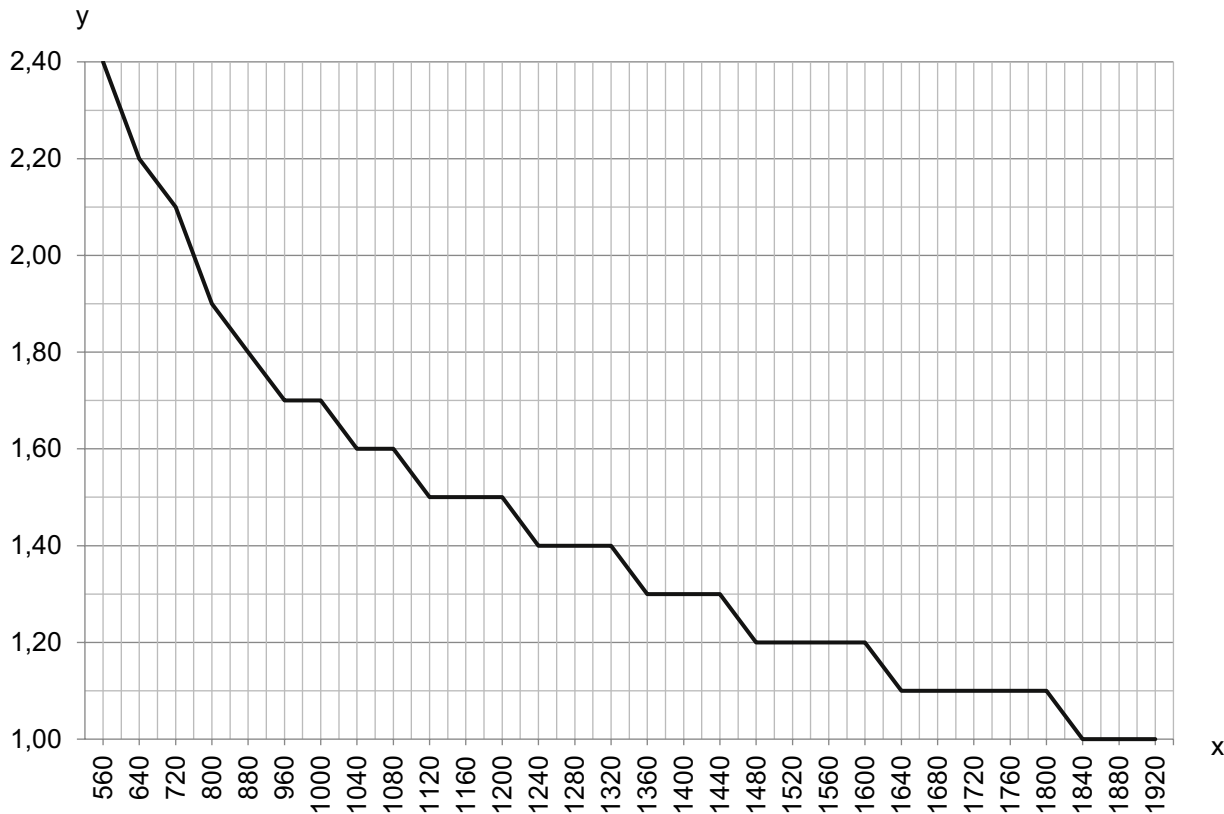

x Total measuring length from width and height measuring light curtain [mm]
 y Max. conveyor speed [m/s]

Notes

Observe intended use!

- This product is not a safety sensor and is not intended as personnel protection.
- The product may only be put into operation by competent persons.
- Only use the product in accordance with its intended use.

Accessories

Connection technology - Interconnection cables

| | Part no. | Designation | Article | Description |
|--|----------|-----------------------------|-----------------------|---|
| | 50135082 | KSS ET-M12-4A-RJ45-A-P7-100 | Interconnection cable | Application: Oil and lubricant resistant Suitable for interface: Ethernet Connection 1: Connector, M12, Axial, Male, D-coded, 4 -pin Connection 2: RJ45 Shielded: Yes Cable length: 10,000 mm Sheathing material: PUR |

Accessories

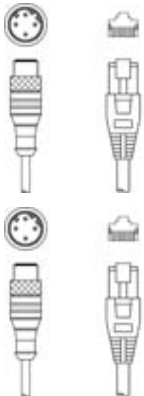
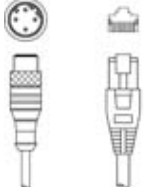
| | Part no. | Designation | Article | Description |
|--|----------|-----------------------------|-----------------------|---|
|  | 50135083 | KSS ET-M12-4A-RJ45-A-P7-150 | Interconnection cable | Application: Oil and lubricant resistant Suitable for interface: Ethernet Connection 1: Connector, M12, Axial, Male, D-coded, 4 -pin Connection 2: RJ45 Shielded: Yes Cable length: 15,000 mm Sheathing material: PUR |
|  | 50135084 | KSS ET-M12-4A-RJ45-A-P7-300 | Interconnection cable | Application: Oil and lubricant resistant Suitable for interface: Ethernet Connection 1: Connector, M12, Axial, Male, D-coded, 4 -pin Connection 2: RJ45 Shielded: Yes Cable length: 30,000 mm Sheathing material: PUR |

Mounting technology - Other

| | Part no. | Designation | Article | Description |
|--|----------|---------------|---------------------|---|
|  | 50143670 | BT 708M-MRSET | Mounting device set | Contains: Mounting material, Mounting profiles Design of mounting device: Profile kit Fastening, at system: Screw type / vertical Mounting bracket, at device: Groove mounting Type of mounting device: Rigid Material: Aluminum Shock absorber: No |
|  | 50143671 | BT 70EM-MRSET | Mounting device set | Contains: Mounting material, Mounting profiles Design of mounting device: Profile kit Fastening, at system: Screw type / vertical Mounting bracket, at device: Groove mounting Type of mounting device: Rigid Material: Aluminum Shock absorber: No |
|  | 50143669 | BT 710M-MRSET | Mounting device set | Contains: Mounting profiles, Mounting material Design of mounting device: Profile kit Fastening, at system: Screw type / vertical Mounting bracket, at device: Groove mounting Type of mounting device: Rigid Material: Aluminum Shock absorber: No |
|  | 50142039 | BT 712M-MRSET | Mounting device set | Contains: Mounting profiles, Mounting material Design of mounting device: Profile kit Fastening, at system: Screw type / vertical Mounting bracket, at device: Groove mounting Type of mounting device: Rigid Material: Aluminum Shock absorber: No |

Note



A list with all available accessories can be found on the Leuze website in the Download tab of the article detailed page.