

Technical data sheet

Single light beam safety device receiver

Part no.: 66553400

MLD520-XR1

Contents

- Technical data
- Dimensioned drawings
- Electrical connection
- Operation and display
- Suitable transmitters
- Part number code
- Accessories



For illustration purposes only



Technical data

Basic data

Series	MLD 500
--------	---------

Functions

Functions	Configuration by means of wiring Contactor monitoring (EDM), selectable Start/restart interlock (RES), selectable
-----------	-------------------------------------------------------------------------------------------------------------------------

Characteristic parameters

Type	4, IEC/EN 61496
SIL	3, IEC 61508
SILCL	3, IEC/EN 62061
Performance Level (PL)	e, EN ISO 13849-1
MTTF _d	204 years, EN ISO 13849-1
PFH _D	6.6E-09 per hour
Mission time T _M	20 years, EN ISO 13849-1
Category	4, EN ISO 13849

Electrical data

Protective circuit	Overvoltage protection Short circuit protected
--------------------	---------------------------------------------------

Performance data

Supply voltage U _B	24 V, DC, -20 ... 20 %
Current consumption, max.	150 mA, Without external load
Fuse	External with max. 3 A

Inputs

Number of digital switching inputs	3 Piece(s)
------------------------------------	------------

Switching inputs

Type	Digital switching input
Switching voltage high, min.	18.2 V
Switching voltage low, max.	2.5 V
Switching voltage, type.	23 V
Voltage type	DC
Switching current, max.	5 mA

Outputs

Number of safety-related switching outputs (OSSDs)	2 Piece(s)
Number of digital switching outputs	1 Piece(s)

Safety-related switching outputs

Type	Safety-related switching output OSSD
Switching voltage high, min.	18.2 V
Switching voltage low, max.	2.5 V
Switching voltage, type.	23 V
Voltage type	DC
Current load, max.	380 mA
Load inductivity	2,200,000 µH
Load capacity	0.3 µF
Residual current, max.	0.2 mA
Residual current, type.	0.002 mA
Voltage drop	1 V

Safety-related switching output 1

Switching element	Transistor, PNP
-------------------	-----------------

Safety-related switching output 2

Switching element	Transistor, PNP
-------------------	-----------------

Switching outputs

Switching voltage high, min.	18.2 V
Switching voltage low, max.	2.5 V
Switching voltage, type.	23 V
Voltage type	DC

Switching output 1

Assignment	Connection 1, pin 1
Switching element	Transistor, PNP
Switching principle	+24 V switching
Function	"State of OSSDs" signal output

Time behavior

Response time	25 ms
Restart delay time	100 ms

Connection

Number of connections	1 Piece(s)
-----------------------	------------

Connection 1

Function	Machine interface
Type of connection	Connector
Thread size	M12
Material	Metal
No. of pins	8 -pin

Cable properties

Permissible conductor cross section, type.	0.25 mm ²
Length of connection cable, max.	100 m
Permissible cable resistance to load, max.	200 Ω

Mechanical data

Design	Cubic
Dimension (W x H x L)	52 mm x 193 mm x 64.7 mm
Housing material	Metal
Metal housing	Aluminum
Lens cover material	Plastic / PMMA
Material of end caps	Diecast zinc
Net weight	600 g
Housing color	Yellow, RAL 1021
Type of fastening	Groove mounting Swivel mount

Operation and display

Type of display	LED
Number of LEDs	1 Piece(s)

Environmental data

Ambient temperature, operation	-30 ... 55 °C
Ambient temperature, storage	-40 ... 75 °C
Relative humidity (non-condensing)	0 ... 95 %

Technical data

Certifications

Degree of protection	IP 67
Protection class	III
Approvals	c TÜV NRTL US c UL US TÜV Süd
US patents	US 6,418,546 B US 7,741,595 B

Classification

Customs tariff number	85365019
ECLASS 5.1.4	27272701
ECLASS 8.0	27272701
ECLASS 9.0	27272701
ECLASS 10.0	27272701
ECLASS 11.0	27272701
ECLASS 12.0	27272701
ECLASS 13.0	27272701
ECLASS 14.0	27272701
ECLASS 15.0	27272701
ECLASS 16.0	27272701
ETIM 5.0	EC001831
ETIM 6.0	EC001831
ETIM 7.0	EC001831
ETIM 8.0	EC001831
ETIM 9.0	EC001831
ETIM 10.0	EC001831
UNSPSC 26.08	32151804

Dimensioned drawings

All dimensions in millimeters

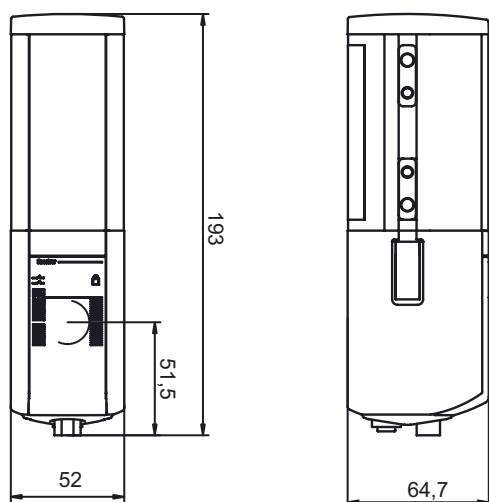

Electrical connection

Connection 1

Function	Machine interface
Type of connection	Connector
Thread size	M12
Type	Male
Material	Metal
No. of pins	8 -pin
Encoding	A-coded

Pin	Pin assignment	Conductor color
1	RES/OSSD status signal	White
2	+24 V	Brown
3	EDM	Green
4	MODE	Yellow
5	OSSD2	Gray
6	OSSD1	Pink
7	0 V	Blue
8	n.c.	Red



Operation and display

LED	Display	Meaning
1	Red, continuous light	OSSD off.
	Green, continuous light	OSSD on
	Red, flashing, 1 Hz	External error
	Red, flashing, 10 Hz	Internal error
	Green, flashing, 1 Hz	Weak signal, device not optimally aligned or soiled.
2	Yellow, continuous light	Start/restart interlock locked.

Suitable transmitters

	Part no.	Designation	Article	Description
	66501400	MLD500-XT1	Single light beam safety device transmitter	Operating range: 20 ... 100 m Light source: LED, Infrared Connection: Connector, M12, Metal, 5 -pin

Part number code

Part designation: MLDxyy-zab/t

MLD Multiple light beam safety device

x	Series 3: MLD 300 5: MLD 500
yy	Function classes 00: transmitter 10: automatic restart 12: external testing 20: EDM/RES 30: muting 35: timing controlled 4-sensor muting

Part number code

MLD Multiple light beam safety device

z	Device type T: transmitter R: receiver RT: transceiver xT: transmitter with high range xR: receiver for high range
a	Number of beams
b	Option L: integrated laser alignment aid (for transmitter/receiver) M: integrated status indicator (MLD 320, MLD 520) or integrated status and muting indicator (MLD 330, MLD 335, MLD 510/A, MLD 530, MLD 535) E: Connection socket for external muting indicator (AS-i models only)
/t	Safety-related switching outputs (OSSDs), connection technology -: transistor output, M12 plug A: Integrated AS-i interface, M12 plug, (safety bus system)





Note



A list with all available device types can be found on the Leuze website at www.leuze.com.

Accessories

Connection technology - Connection cables

	Part no.	Designation	Article	Description
	50135129	KD S-M12-8A-P1-100	Connection cable	Application: Oil and lubricant resistant Connection 1: Connector, M12, Axial, Female, A-coded, 8 -pin Connector, LED: No Connection 2: Open end Shielded: Yes Cable length: 10,000 mm Sheathing material: PUR
	50135130	KD S-M12-8A-P1-150	Connection cable	Application: Oil and lubricant resistant Connection 1: Connector, M12, Axial, Female, A-coded, 8 -pin Connector, LED: No Connection 2: Open end Shielded: Yes Cable length: 15,000 mm Sheathing material: PUR
	50135131	KD S-M12-8A-P1-250	Connection cable	Application: Oil and lubricant resistant Connection 1: Connector, M12, Axial, Female, A-coded, 8 -pin Connector, LED: No Connection 2: Open end Shielded: Yes Cable length: 25,000 mm Sheathing material: PUR
	50135132	KD S-M12-8A-P1-500	Connection cable	Application: Oil and lubricant resistant Connection 1: Connector, M12, Axial, Female, A-coded, 8 -pin Connector, LED: No Connection 2: Open end Shielded: Yes Cable length: 50,000 mm Sheathing material: PUR

Accessories

Muting - Mounting systems

	Part no.	Designation	Article	Description
	424421	BT-SB10	Mounting bracket set	Design of mounting device: Mounting clamp Fastening, at system: Through-hole mounting Mounting bracket, at device: Clampable Type of mounting device: Swiveling Swivel range: -8 ... 8 ° Material: Metal

Services

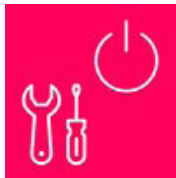
	Part no.	Designation	Article	Description
	S981050	CS40-I-140	Safety inspection	Details: Checking of a safety light barrier application in accordance with current standards and guidelines. Inclusion of the device and machine data in a database, production of a test log per application. Conditions: It must be possible to stop the machine, support provided by customer's employees and access to the machine for Leuze employees must be ensured.
	S981046	CS40-S-140	Start-up support	Details: For safety devices including stopping time measurement and initial inspection. Conditions: Devices and connection cables are already mounted, price not including travel costs and, if applicable, accommodation expenses.

Note



↪ A list with all available accessories can be found on the Leuze website in the Download tab of the article detailed page.