

Technical data sheet

Safety light curtain receiver

Part no.: 72001112

ELC110R17-1200



Contents

- Technical data
- Dimensioned drawings
- Electrical connection
- Circuit diagrams
- Operation and display
- Suitable transmitters
- Part number code
- Notes
- Accessories



For illustration purposes only

Technical data

Basic data

Series	ELC100
Device type	Receiver
Contains	2x sliding block
Application	Finger protection

Functions

Functions	Automatic start/restart
-----------	-------------------------

Characteristic parameters

Type	4, IEC/EN 61496
SIL	3, IEC 61508
SILCL	3, IEC/EN 62061
Performance Level (PL)	e, EN ISO 13849-1
PFH _D	8E-09 per hour
Mission time T _M	20 years, EN ISO 13849-1
Category	4, EN ISO 13849

Protective field data

Resolution	17 mm
Protective field height	1,200 mm

Optical data

Synchronization	Optical between transmitter and receiver
-----------------	--

Electrical data

Protective circuit	Overvoltage protection Short circuit protected
--------------------	---

Performance data

Supply voltage U _B	24 V, DC, -20 ... 20 %
Current consumption, max.	100 mA

Outputs

Number of safety-related switching outputs (OSSDs)	2 Piece(s)
--	------------

Safety-related switching outputs

Type	Safety-related switching output OSSD
Switching voltage high, min.	18 V
Switching voltage low, max.	2.5 V
Switching voltage, type.	22.5 V
Voltage type	DC
Current load, max.	50 mA
Load inductivity	500,000 µH
Load capacity	0.03 µF
Residual current, max.	0.5 mA
Voltage drop	1.5 V

Safety-related switching output 1

Assignment	Connection 1, pin 2
Switching element	Transistor, PNP

Safety-related switching output 2

Assignment	Connection 1, pin 4
Switching element	Transistor, PNP

Time behavior

Response time	17.3 ms
Restart delay time	100 ms

Connection

Number of connections	1 Piece(s)
-----------------------	------------

Connection 1

Function	Machine interface
Type of connection	Cable with connector
Cable length	300 mm
Sheathing material	PUR
Number of conductors	4 -wire
Thread size	M12
Material	Metal
No. of pins	4 -pin

Cable properties

Permissible conductor cross section, type.	0.25 mm ²
Length of connection cable, max.	25 m
Permissible cable resistance to load, max.	20 Ω

Mechanical data

Dimension (W x H x L)	34.7 mm x 1,215 mm x 39.3 mm
Housing material	Metal
Metal housing	Aluminum
Lens cover material	Plastic / PMMA
Material of end caps	Diecast zinc
Net weight	1,730 g
Housing color	Yellow, RAL 1021
Type of fastening	Groove mounting Mounting brackets

Operation and display

Type of display	LED
Number of LEDs	6 Piece(s)

Environmental data

Ambient temperature, operation	0 ... 50 °C
Ambient temperature, storage	-30 ... 70 °C
Relative humidity (non-condensing)	0 ... 95 %

Certifications

Degree of protection	IP 65
Protection class	III
Approvals	c UL US KCs TÜV Süd
Vibration resistance	50 m/s ²
US patents	US 6,418,546 B

Technical data

Customs tariff number	85365019
ECLASS 5.1.4	27272704
ECLASS 8.0	27272704
ECLASS 9.0	27272704
ECLASS 10.0	27272704
ECLASS 11.0	27272704
ECLASS 12.0	27272704
ECLASS 13.0	27272704
ECLASS 14.0	27272704
ECLASS 15.0	27272704
ETIM 5.0	EC002549
ETIM 6.0	EC002549
ETIM 7.0	EC002549
ETIM 8.0	EC002549
ETIM 9.0	EC002549
ETIM 10.0	EC002549

Dimensioned drawings

All dimensions in millimeters

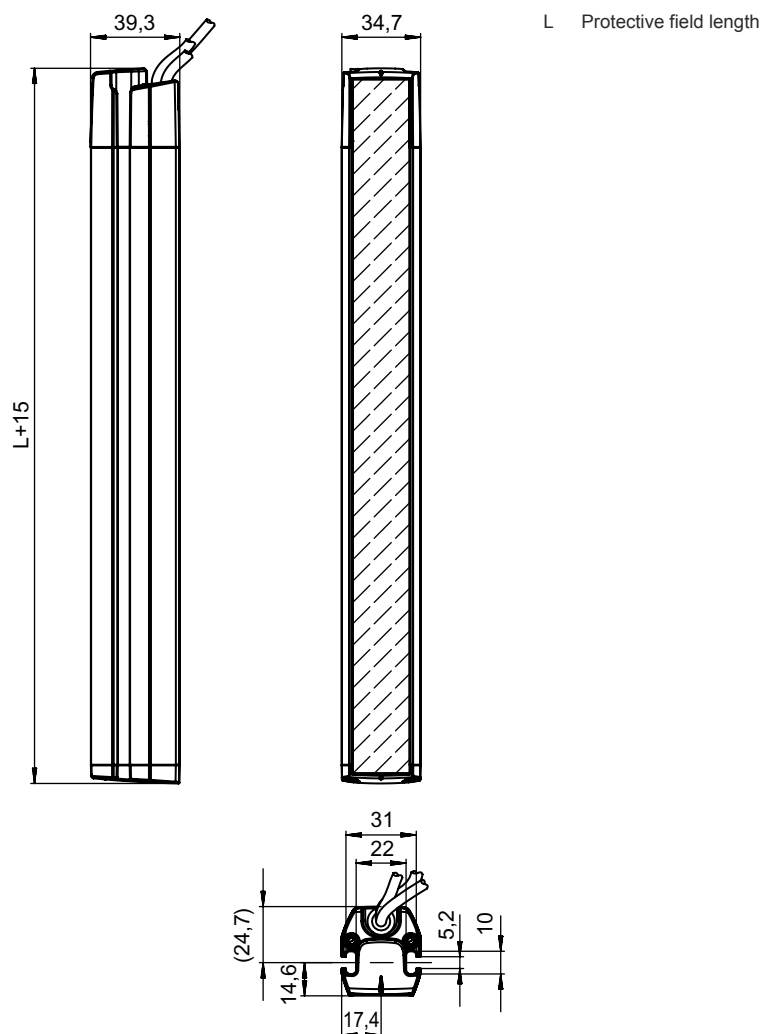

Electrical connection

Connection 1

Function	Machine interface
Type of connection	Cable with connector
Cable length	300 mm
Sheathing material	PUR
Cable color	Black
Number of conductors	4 -wire
Wire cross section	0.2 mm ²
Thread size	M12
Type	Male
Material	Metal
No. of pins	4 -pin
Encoding	A-coded

Pin	Pin assignment	Conductor color
1	+24 V	Brown
2	OSSD1	White
3	0 V	Blue
4	OSSD2	Black



Circuit diagrams

Connection diagram receiver



Circuit diagram example with downstream MSI-SR4B safety relay

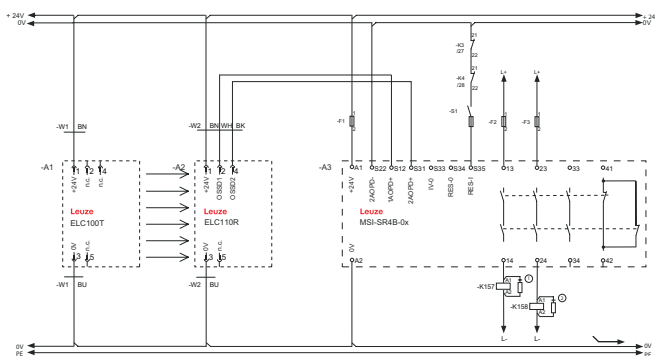

1.2 Spark extinction circuit, suitable spark extinction provided

Operation and display

LED	Display	Meaning
1	Red, continuous light	OSSD off
	red, slowly flashing (0.5 Hz)	External error
	red, flashing fast (10 Hz)	Internal error
	Flash sequence 2x ON/OFF, followed by a pause	Connection error
2	Green, continuous light	OSSD on
3	Blue, flashing	Light reception strength 1
	Blue, continuous light	Light reception strength 2
4	Blue, flashing	Light reception strength 3
	Blue, continuous light	Light reception strength 4, OSSD switches on
5	Blue, flashing	Light reception strength 5
	Blue, continuous light	Light reception strength 6
6	Blue, flashing	Light reception strength 7
	Blue, continuous light	Light reception strength 8, optimum alignment
	Blue, very quickly flashing	Fault in light reception

Suitable transmitters

	Part no.	Designation	Article	Description
	72000112	ELC100T17-1200	Safety light curtain transmitter	Resolution: 17 mm Protective field height: 1.200 mm Operating range: 0.5 ... 3 m Connection: Cable with connector, M12, Metal, 4 -pin, 200 mm, PUR

Part number code

Part designation: **ELC1yyzaa-hhhh**



ELC	Safety light curtain
x	Series 1: ELC100
yy	Function classes 00: transmitter 10: receiver – automatic restart
z	Device type T: transmitter R: receiver
a	Resolution 17: 17 mm 30: 30 mm
hhhh	Protective field height 300 ... 1500: from 300 mm to 1500 mm

Note



↳ A list with all available device types can be found on the Leuze website at www.leuze.com.

Notes

 Observe intended use!	
	<ul style="list-style-type: none"> ↪ The product may only be put into operation by competent persons. ↪ Only use the product in accordance with its intended use.

Accessories

Connection technology - Connection cables

	Part no.	Designation	Article	Description
	50133860	KD S-M12-5A-P1-050	Connection cable	Connection 1: Connector, M12, Axial, Female, A-coded, 5 -pin Connector, LED: No Connection 2: Open end Shielded: Yes Cable length: 5.000 mm Sheathing material: PUR

Mounting technology - Other

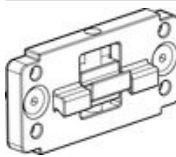
	Part no.	Designation	Article	Description
	424439	BT-2P45	Mounting bracket	Bore hole 1: M6 Bore hole 2: M6 Design of mounting device: Mounting clamp Fastening, at system: Groove mounting Mounting bracket, at device: Groove mounting Type of mounting device: Clampable, Suitable for mounting in UDC-S2, DC-S2 device columns Material: Metal

Services

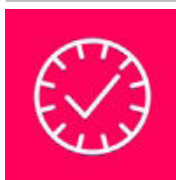
	Part no.	Designation	Article	Description
	S981050	CS40-I-140	Safety inspection	Details: Checking of a safety light barrier application in accordance with current standards and guidelines. Inclusion of the device and machine data in a database, production of a test log per application. Conditions: It must be possible to stop the machine, support provided by customer's employees and access to the machine for Leuze employees must be ensured.
	S981046	CS40-S-140	Start-up support	Details: For safety devices including stopping time measurement and initial inspection. Conditions: Devices and connection cables are already mounted, price not including travel costs and, if applicable, accommodation expenses.

Note	
	↪ A list with all available accessories can be found on the Leuze website in the Download tab of the article detailed page.