

## Technical data sheet

### Diffuse sensor with background suppression

Part no.: 50142314

HRT 25B/L69.32-2500



For illustration purposes only

#### Contents

- Technical data
- Dimensioned drawings
- Electrical connection
- Diagrams
- Operation and display
- Part number code
- Notes
- Further information
- Accessories



## Technical data

### Basic data

Series	25B
Operating principle	Diffuse reflection principle with background suppression

### Special version

Special version	2 independent switching outputs
	Deactivation input
	Teach via IO-Link

### Optical data

Operating range	0.05 ... 2.5 m (guaranteed operating range)
Operating range limit	0.05 ... 3 m (typical operating range)
Beam path	Divergent
Light source	LED, Infrared
Wavelength	850 nm
Transmitted-signal shape	Pulsed
LED group	Exempt group (in acc. with EN 62471)
Light spot size [at sensor distance]	60 mm [1,000 mm]
Type of light spot geometry	Round

### Measurement data

Repeatability	<± 15 mm, for measurement range 50–2500 mm, depending on diffuse reflectance and object distance, at 20°C after 20 mins warmup time, average range $U_B$ , measurement object $\geq 50 \times 50 \text{ mm}^2$
Setting accuracy (via IO link)	± 10% (300–2500 mm)
Temperature drift	2 mm/K
Black/white behavior	25 mm, 2–90% diffuse reflectance

### Electrical data

Protective circuit	Polarity reversal protection
	Short circuit protected
	Transient protection

### Performance data

Supply voltage $U_B$	18 ... 30 V, DC
Residual ripple	0 ... 15 %, From $U_B$
Open-circuit current	0 ... 32 mA

### Inputs

Number of deactivation inputs	1 Piece(s)
-------------------------------	------------

### Deactivation inputs

Type	Deactivation input
Voltage type	DC
Switching voltage	high: $\geq 8 \text{ V}$ low: $\leq 2 \text{ V}$
Input resistance	10,000 $\Omega$
Activation/disable delay	20 ms

### Deactivation input 1

Active switching state	Low
------------------------	-----

### Outputs

Number of digital switching outputs	2 Piece(s)
-------------------------------------	------------

### Switching outputs

Type	Digital switching output
Voltage type	DC
Switching current, max.	50 mA
Switching voltage	high: $\geq (U_B - 2 \text{ V})$ low: $\leq 2 \text{ V}$

### Switching output 1

Switching element	Transistor, Push-pull
Switching principle	IO-Link / light switching (PNP)/dark switching (NPN)

### Switching output 2

Switching element	Transistor, Push-pull
Switching principle	Light switching (PNP)/dark switching (NPN)

### Time behavior

Switching frequency	2 ... 30 Hz, depending on diffuse reflectance
Response time	70 ms, depending on diffuse reflectance
Readiness delay	300 ms

### Interface

Type	IO-Link
<b>IO-Link</b>	
COM mode	COM2
Min. cycle time	COM2 = 2.3 ms
Frame type	2.1
Specification	V1.1.1
SIO-mode support	Yes
Dual Channel	Yes

### Connection

Number of connections	1 Piece(s)
-----------------------	------------

### Connection 1

Function	Signal IN
	Signal OUT
	Voltage supply
Type of connection	Cable
Cable length	2,000 mm
Sheathing material	PUR
Cable color	Black
Number of conductors	5 -wire
Wire cross section	0.15 mm <sup>2</sup>

### Mechanical data

Dimension (W x H x L)	15 mm x 38.9 mm x 28.7 mm
Housing material	Plastic
Plastic housing	PC-ABS
Lens cover material	Plastic / PMMA
Net weight	15 g
Housing color	Red
Type of fastening	Through-hole mounting
	Via optional mounting device
Recommended tightening torque for M3 fastening	0.9 N·m
Recommended tightening torque for M4 fastening	1.4 N·m

## Technical data

### Operation and display

Type of display	LED
Number of LEDs	3 Piece(s)
Operational controls	Teach button
Function of the operational control	Range adjustment

### Environmental data

Ambient temperature, operation	-30 ... 50 °C
Ambient temperature, storage	-40 ... 60 °C

### Certifications

Degree of protection	IP 66
	IP 67
Protection class	III
Approvals	c UL US
Standards applied	IEC 60947-5-2

### Classification

Customs tariff number	85365019
ECLASS 5.1.4	27270904
ECLASS 8.0	27270904
ECLASS 9.0	27270904
ECLASS 10.0	27270904
ECLASS 11.0	27270904
ECLASS 12.0	27270903
ECLASS 13.0	27270903
ECLASS 14.0	27270903
ECLASS 15.0	27270903
ECLASS 16.0	27270903
ETIM 5.0	EC002719
ETIM 6.0	EC002719
ETIM 7.0	EC002719
ETIM 8.0	EC002719
ETIM 9.0	EC002719
ETIM 10.0	EC002719
UNSPSC 26.08	39121528

# Dimensioned drawings

All dimensions in millimeters

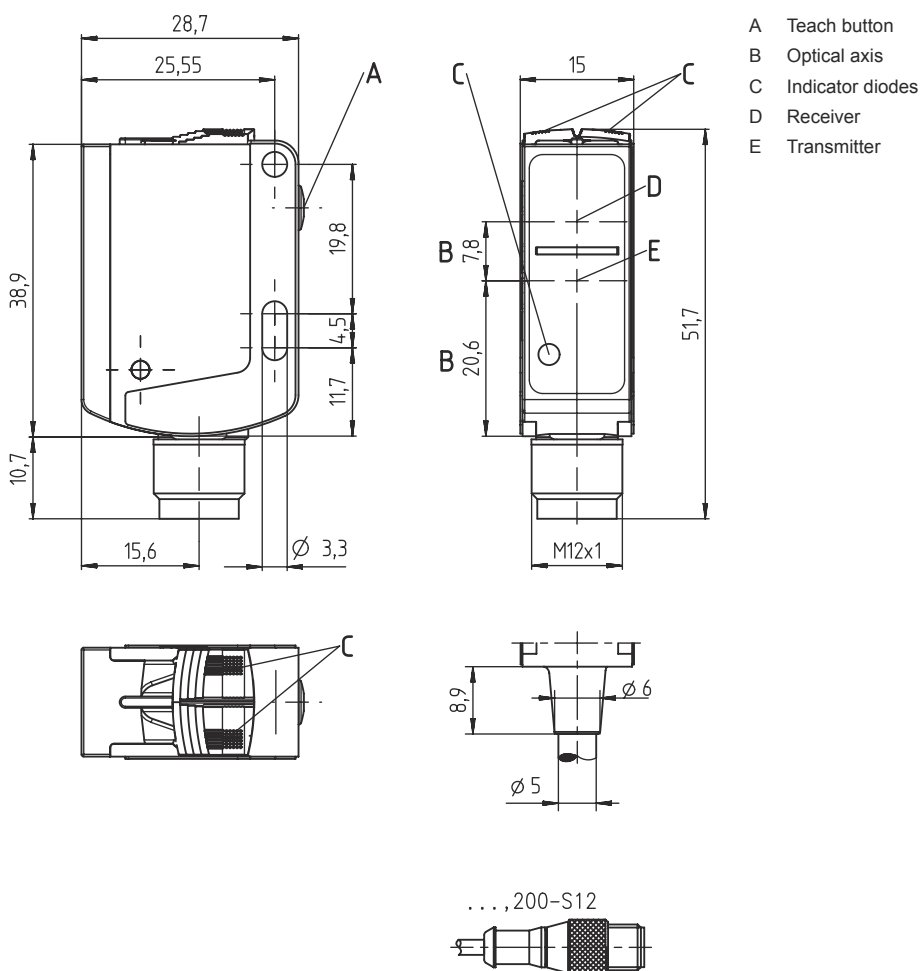

## Electrical connection

### Connection 1

Function	Signal IN
	Signal OUT
	Voltage supply
Type of connection	Cable
Cable length	2,000 mm
Sheathing material	PUR
Cable color	Black
Number of conductors	5 -wire
Wire cross section	0.15 mm <sup>2</sup>

### Conductor color

### Conductor assignment

Brown	V+
White	OUT 2
Blue	GND
Black	IO-Link / OUT 1
Gray	IN 1

# Diagrams

## Typ. response behavior

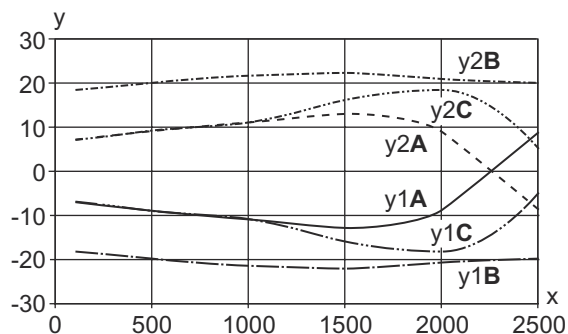

x Distance [mm]  
y Misalignment [mm]

y1/2A Object: white, background: white  
y1/2B Object: white, background: black  
y1/2C Object: black, background: black

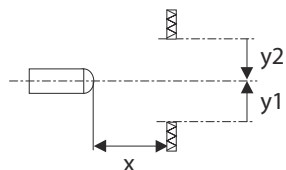

## Black/white behavior

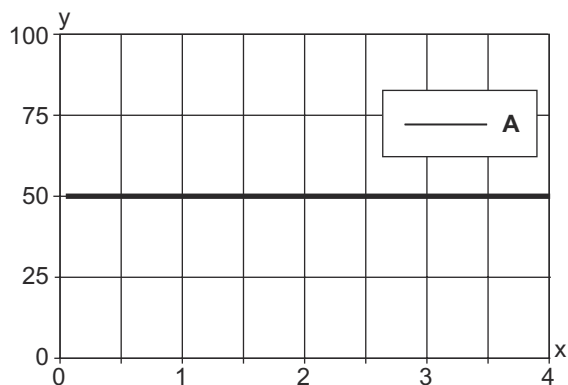

x Range [mm]  
y Max. range change [mm] (reference: white 90%)  
A 4 ... 90% diffuse reflectance

## Operation and display

LED	Display	Meaning
1	Green, continuous light	Operational readiness
2	Yellow, continuous light	Object detected (switching output Q1)
3	Yellow, continuous light	Object detected (switching output Q1)
	Blue, continuous light	Object detected (switching output Q2)
	White, continuous light	Object detected (switching output Q1 and Q2)

## Part number code

Part designation: AAA25B d EFG.HHH-i,J

AAA	<b>Operating principle / construction</b> HRT25B: Diffuse reflection sensor with background suppression ODT25B: Distance diffuse sensor with background suppression
d	<b>Light type</b> n/a: red light
E	<b>Assignment pin 4/conductor BK</b> L: IO-Link (with dual channel, also push/pull switching output Q1)

## Part number code

<b>F</b>	<b>Assignment pin 2/conductor WH</b> 6: Push/pull (pushover) switching output Q2
<b>G</b>	<b>Assignment pin 5/conductor GY</b> 6: Push/pull (pushover) switching output Q3 9: Deactivation input (factory settings) or teach input (> 8VDC, parameterizable) T: Teach input for external teach-in (> 8VDC, parameterizable) X: n.c.
<b>HH</b>	<b>Equipment</b> 32: Teach button for teach-in including range adjustment via IO-Link
<b>i</b>	<b>Scanning range</b> xxxx: Max. operating range
<b>J</b>	<b>Electrical connection</b> n/a: Cable, length 2,000 mm with wire-end sleeves, 5 wires -S12: M12 connector, 5-pin ,200-S12: Cable, length 200 mm with M12 connector, 5-pin

### Note



A list with all available device types can be found on the Leuze website at [www.leuze.com](http://www.leuze.com).

## Notes



### Observe intended use!



- ⌘ This product is not a safety sensor and is not intended as personnel protection.
- ⌘ The product may only be put into operation by competent persons.
- ⌘ Only use the product in accordance with its intended use.



### For UL applications:



- ⌘ For UL applications, use is only permitted in Class 2 circuits in accordance with the NEC (National Electric Code).

## Further information



- Light source: Average life expectancy 100,000 h at an ambient temperature of 25 °C
- Values apply to measurement range 50–2,500 mm, depending on diffuse reflectance and object distance, at 20 °C after 20 mins warmup time, average range  $U_B$ , measurement object  $\geq 50 \times 50 \text{ mm}^2$ .

## Accessories



### Connection technology - Connection unit

	Part no.	Designation	Article	Description
	50144900	MD 798i-11-82/L5-2222	IO-Link master	Current consumption, max.: 11,000 mA Interface: IO-Link, Automatic protocol detection, EtherNet IP, Modbus TCP, PROFINET Connections: 12 Piece(s) Sensor connections: 8 Piece(s) Degree of protection: IP 67, IP 65, IP 69K

### Mounting technology - Mounting brackets

	Part no.	Designation	Article	Description
	50124651	BT 205M-10SET	Mounting device set	Contains: 10x Design of mounting device: Angle, L-shape Fastening, at system: Through-hole mounting Mounting bracket, at device: Screw type Type of mounting device: Rigid Material: Metal
	50040269	BT 25	Mounting device	Design of mounting device: Angle, L-shape Fastening, at system: Through-hole mounting Mounting bracket, at device: Screw type Type of mounting device: Rigid Material: Metal

### Mounting technology - Rod mounts

	Part no.	Designation	Article	Description
	50117829	BTP 200M-D12	Mounting system	Design of mounting device: Protection hood Fastening, at system: For 12 mm rod Mounting bracket, at device: Screw type Type of mounting device: Clampable, Adjustable, Turning, 360° Material: Metal
	50117255	BTU 200M-D12	Mounting system	Contains: 2x M3 x 16 screw, 2 M3 x 20 screws, 2x position washers Design of mounting device: Mounting system Fastening, at system: For 12 mm rod, Sheet-metal mounting Mounting bracket, at device: Screw type, Suited for M3 screws Type of mounting device: Clampable, Adjustable, Turning, 360° Material: Metal

#### Note



A list with all available accessories can be found on the Leuze website in the Download tab of the article detailed page.

## Interface

### IO-Link interface

Sensors in the HRT 25B/L... variant have a dual channel architecture. The IO-Link interface in accordance with specification 1.1.1 (October 2011) is provided on pin 4 (Q1). This allows the devices to be configured quickly and easily and, therefore, cost-effectively. Furthermore, the sensor transmits its process data and makes diagnostic information available through it.

Parallel to the IO-Link communication, the sensor can output the continuous switching signal for object detection on Q2. The IO-Link communication does not interrupt this signal.

### IO-Link process data format

(IO-Link 1.1, M-sequence TYPE\_2\_1)

#### Output data device (8 bit)

Data bit	Assignment	Meaning
7	Switching output Q1	0 = inactive, 1 = active
6	Switching output Q2	0 = inactive, 1 = active
5	Switching output Q3	0 = inactive, 1 = active (if Q3 not present = 0)
4	Measurement	0 = initialization/teach/deactivation, 1 = running measurement
3	Signal	0 = no signal or signal too weak, 1 = signal ok
2	Warning	0 = no warning, 1 = warning, e.g., weak signal
1	0	Not assigned (initial state = 0)
0	0	Not assigned (initial state = 0)

#### Device input data

None

### Device-specific IODD

At [www.leuze.com](http://www.leuze.com) in the download area for IO-Link sensors you will find the **IODD zip file** with all data required for the installation.

### IO-Link parameter documentation

A complete description of the IO-Link parameters is given in the \*.html files. Please double-click one of the two language variants: **\*IODD\*-de.html** for **German** or **\*IODD\*-en.html** for **English**.

## Teach settings

### Sensor adjustment (teach) via teach button

Teach	Operating level 1	Operating level 2
Teaching of two individual switching points	<p><b>Teach on object for Q1 (pin 4):</b></p> <p>With this teach mode, the switching distance for switching output Q1 is configured in such a way that the object which is in the beam path during the teach procedure is reliably detected.</p> <p>Switching output Q1 (pin 4)</p> <p><b>Hysteresis H:</b></p> <p>To ensure continuous object detection in the switching point, the sensor has a switch hysteresis. Object is no longer detected if: distance to sensor &gt; teach point + reserve + hysteresis.</p>	<p><b>Teach on object for Q2 (pin 2):</b></p> <p>With this teach mode, the switching distance for switching output Q2 is configured in such a way that the object which is in the beam path during the teach procedure is reliably detected.</p> <p>Switching output Q2 (pin 2)</p>

#### NOTE



The sensors have a factory-set hysteresis **H** of 50 mm.

#### Operation via teach button

##### Teach-in on operating level 1 (switching distance for Q1)

- Press teach button until both LEDs flash simultaneously.
- Release teach button.
- Ready.

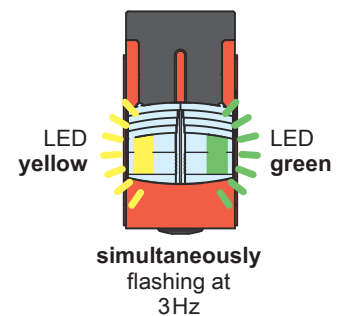
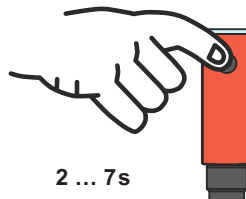

##### Teach-in on operating level 2 (switching distance for Q2)

- Press teach button until both LEDs flash alternately.
- Release teach button.
- Ready.

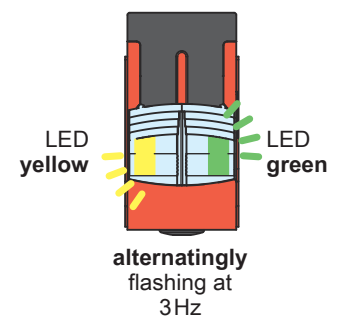

## Teach settings

### Adjusting the switching behavior of the switching output – light/dark switching

This function permits inversion of the sensors' switching logic.

- Press teach button until only the green LED flashes. Yellow LED:  
ON = switching outputs light switching (in the case of complementary sensors, Q1 (pin 4) light switching, Q2 (pin 2) dark switching), this means output active when object is detected.
- OFF = switching outputs dark switching (in the case of complementary sensors, Q1 (pin 4) dark switching, Q2 (pin 2) light switching), this means output inactive when object is detected.
- Release teach button.  
The yellow LED then indicates the toggled switching logic.
- Ready.

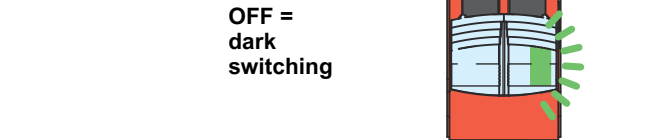
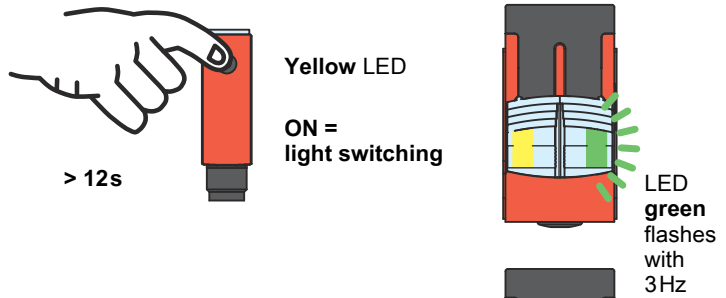

### Set factory defaults

It's possible to restore the factory settings of the sensor via the teach button.

- Hold down the teach button during power-on. The green and yellow LEDs flash simultaneously at 3Hz.
- Release the teach button. The green and yellow LEDs flash alternately at 3Hz.
- Press the teach button. The green and yellow LEDs flash simultaneously at 9Hz.
- Release the teach button. The factory settings are restored and the sensor is restarted.

